

AC 220-5

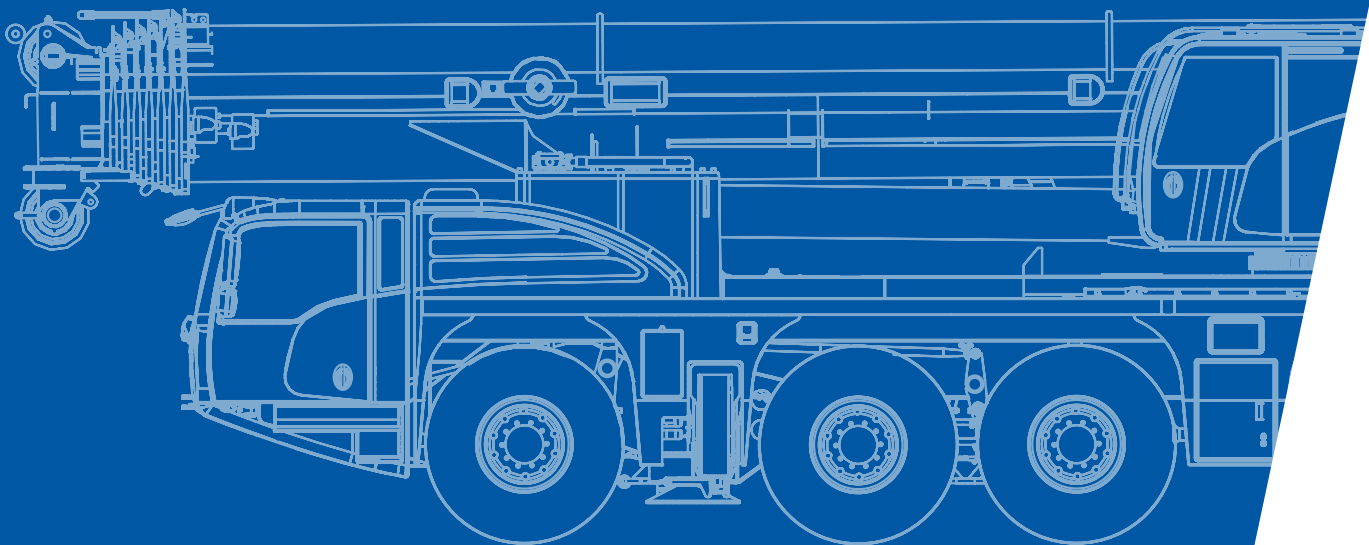

**All Terrain Crane
245 USt Capacity class**

DEMAG[®]
BY TEREX 

	Page:
Dimensions.....	4
Specifications.....	6
Equipment.....	7
Counterweight.....	8

 HA Main boom	9
--	---

 HAV Folding swing-away jib	22
--	----

 MS Runner	26
---	----

Technical description.....	32
----------------------------	----

	Counterweight		Boom telescoping
	Lifting capacities on outriggers - 360°		Boom elevation
	Radius		Working speeds
	Main boom		Max. line pull
	Folding swing-away jib		Rope diameter
	Runner		Rope length
	Max. axle loads		Hook block (capacity-sheaves-rope diameter)
	Mechanism		Number of lines
	Tires		Possible load of hook block
	Hook block		Weight of hook block
	Hoist		Distance head sheave axle – hook ground
	Dolly		Number of sheaves in boom head
	Travel speed		Supporting force
	Gradeability – road		Length of stroke (support cylinders)
	Gradeability – off road		Payload incl. rear storage box
	Slewing		Additional parts for hydraulic system

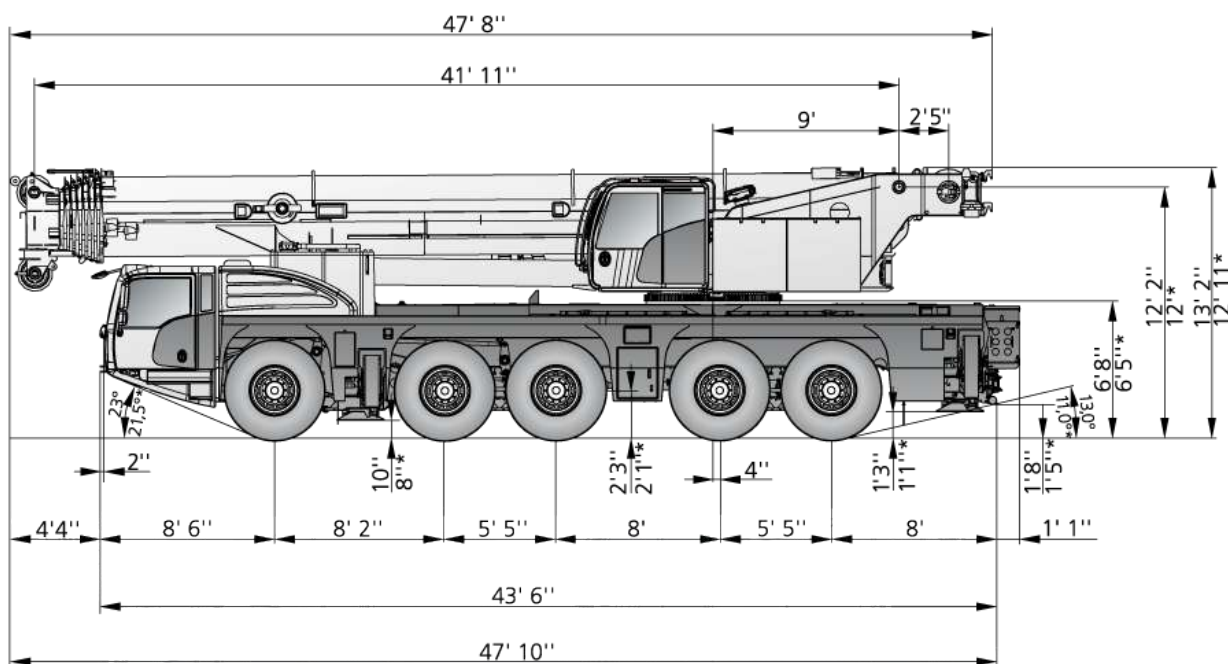

⊙ 445/95 R25 / 525/80 R25

* ⊙ 385/95 R25

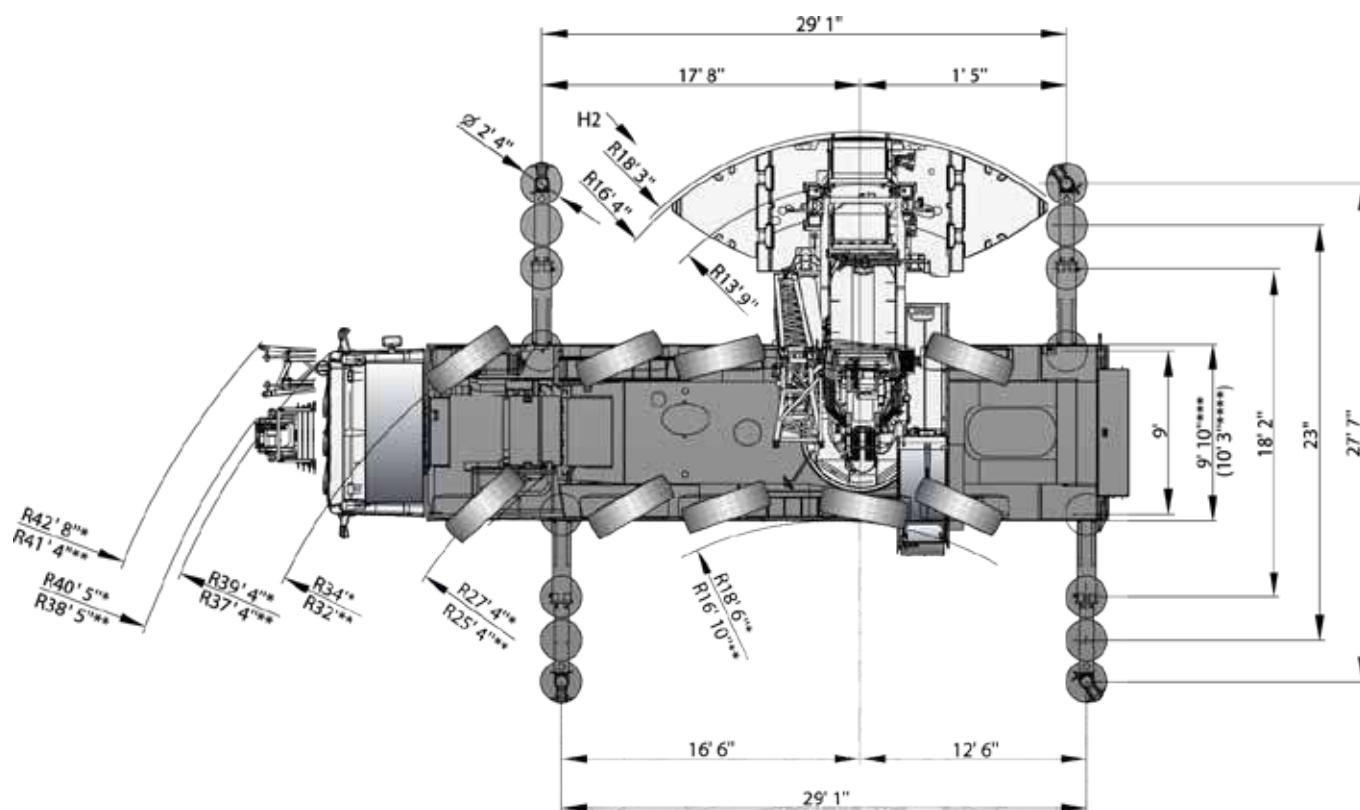

* steering mode 2

** steering mode 3











***  385/95 R25 / 445/95 R25





****  525/80 R25

see page 6



Specifications

AC 220-5

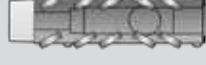

											
	Total										
< 20,000 lb					On request!						X
18,700 lb	83,800 lb	10x6x10	385/95R25	–	–	–	–	–	–	–	
26,500 lb	132,300 lb	10x8x10	445/95R25	255.9 ft	–	–	–	–	1320 lb	–	
29,100 lb	138,900 lb	10x8x10	445/95R25	255.9 ft	32-1-21	–	68.9 ft	–	2095 lb	–	
36,400 lb	180,800 lb	10x8x10	445/95R25	255.9 ft	32-1-21	41,200 lb	68.9 ft	X	1760 lb	–	









	1 Highway > 28 mph		4* Off-wall
	2 City < 28 mph		5* Crab steer mode
	3* Minimum turning radius < 3.1 mph		6* All wheel steering







*must be activated

		
209,500 lb	231,500 lb	52.8 mph ¹⁾
	16.9 in	

¹⁾ Depending on tire type, size and country specific legislation

	385 / 95 R 25 14.00 R25	445 / 95 R 25 16.00 R25	525 / 80 R 25 20.50 R25
	47 %	40 %	40 %
	64 %	53 %	53 %

				
1	394 ft/min	22,076 lbf	0.83 in	1083 ft
2	394 ft/min	22,076 lbf	0.83 in	1083 ft
	1,40 min ⁻¹			
	ca. 615 s (42.0-255.9 ft)			
	ca. 49 s (-1,4° - 82°)			

					
1	21,800	12-0-21	4	770 lb	6.6 ft
2	43,400	32-1-21	4	1320 lb	8.9 ft
3	64,800	32-1-21	4	1320 lb	8.9 ft
4	86,200	80-3-21	4	1870 lb	9.8 ft
5	107,200	80-3-21	4	1870 lb	9.8 ft
6	127,900	80-3-21	4	1870 lb	9.8 ft
7	148,400	80-3-21	4	1870 lb	9.8 ft
8	168,900	125-5-21	4	2480 lb	9.8 ft
9	189,000	125-5-21	4 + 1	2480 lb	9.8 ft
10	209,000	125-5-21	4 + 1	2480 lb	9.8 ft
12	248,300	160-7-21	4 + 1 + 2	3310 lb	9.8 ft
14	286,600	160-7-21	4 + 1 + 2	3310 lb	9.8 ft

HAV

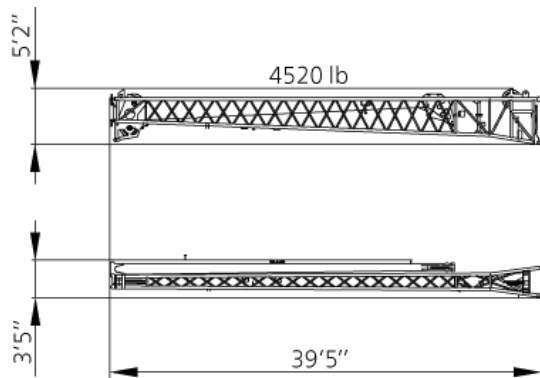

HAV 68.9 ft

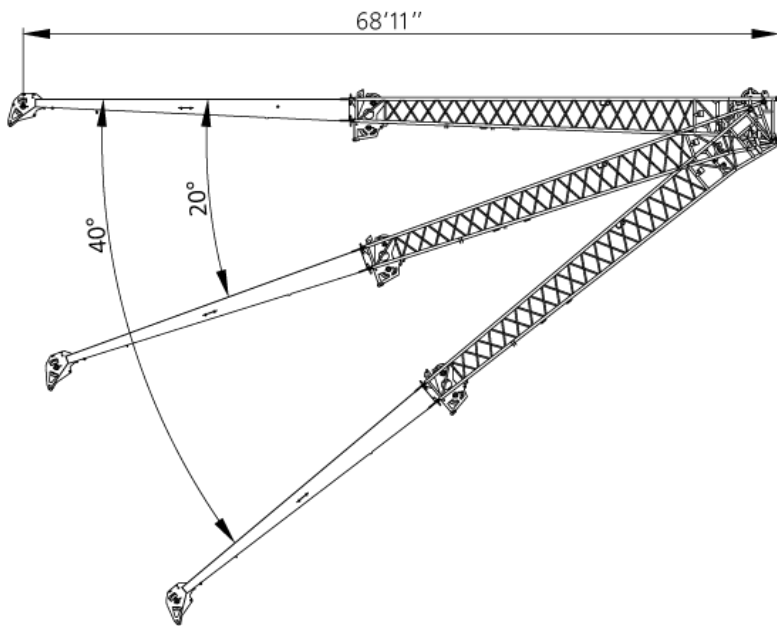

HAV 36.1 ft

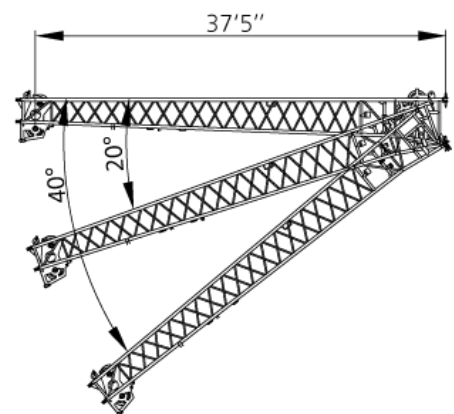

Counterweight

AC 220-5

Parts

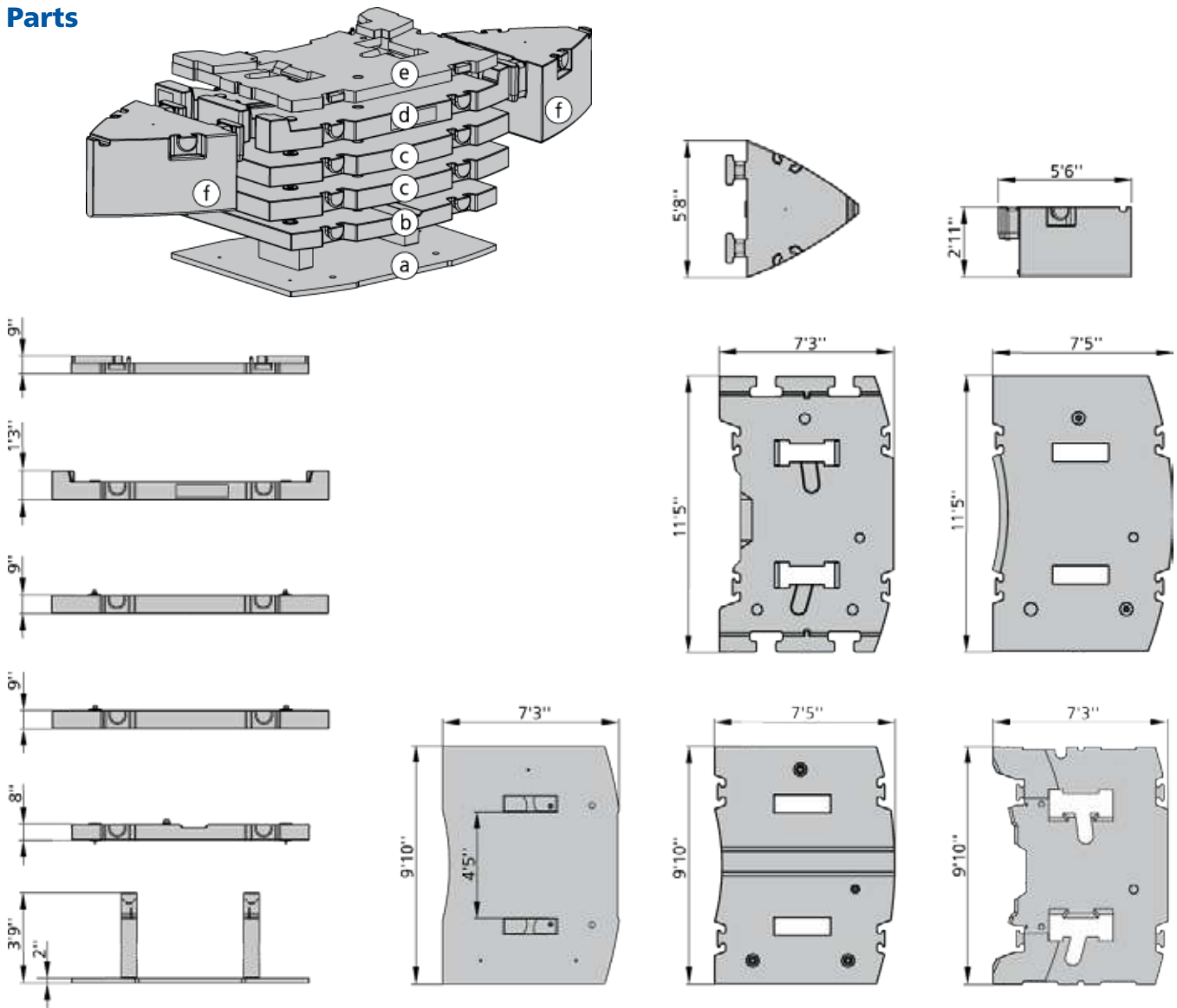

Configurations

	Ⓐ 11,250 lb	Ⓑ 17,640 lb	Ⓒ 24,700 lb	Ⓓ 24,700 lb	Ⓔ 23,150 lb	Ⓕ 12,350 lb	Ⓖ 20,500 lb	Ⓗ 20,500 lb
0 lb								
11,250 lb	X							
28,900 lb	X	X						
41,200 lb	X	X				X		
53,600 lb	X	X	X					
65,900 lb	X	X	X			X		
78,300 lb	X	X	X	X				
90,600 lb	X	X	X	X		X		
101,400 lb	X	X	X	X	X			
113,800 lb	X	X	X	X	X	X		
154,800 lb	X	X	X	X	X	X	X	X

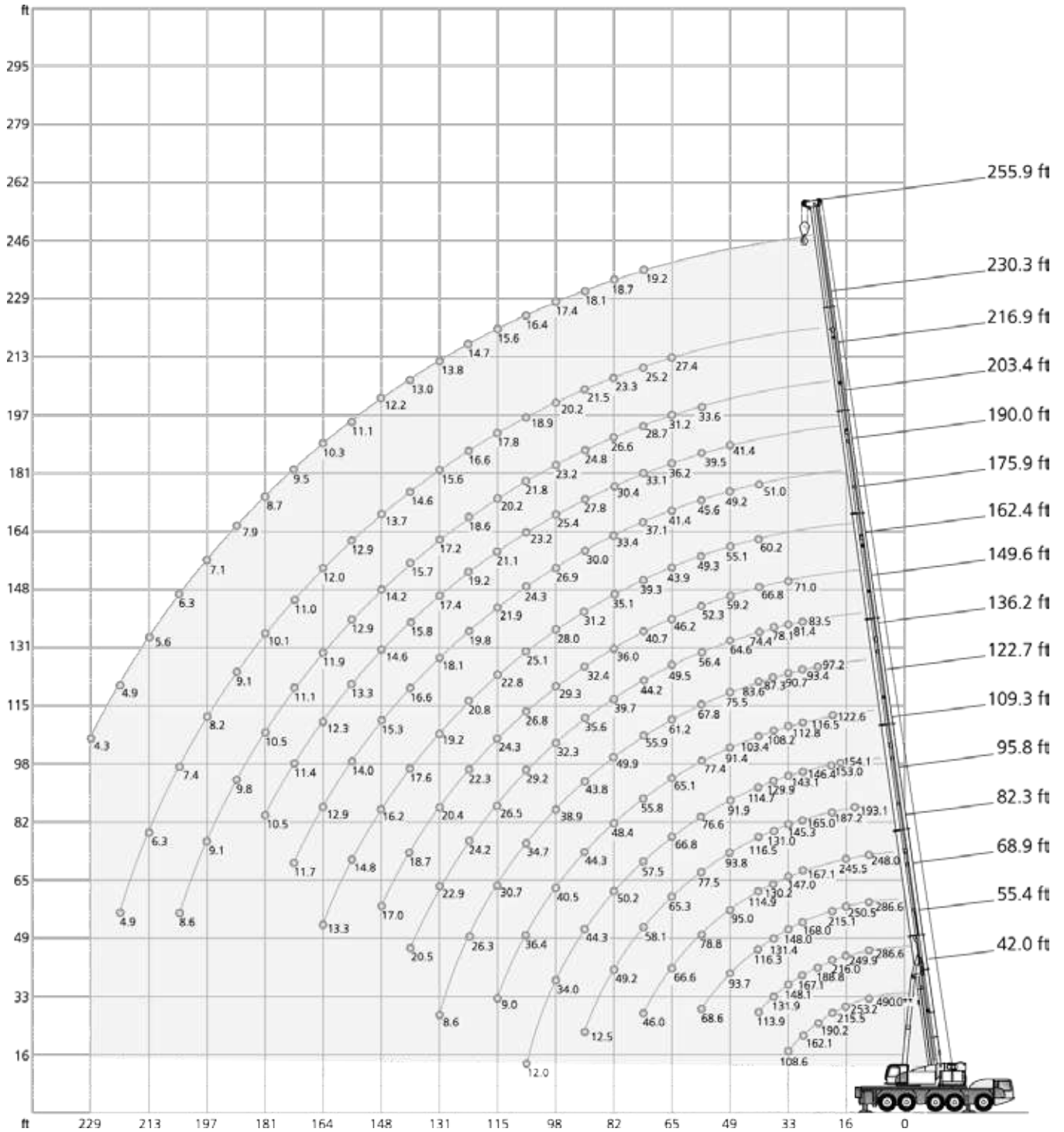
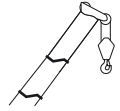

** Capacity class

☰ 154,800 lb		📏 27.60 ft x 29.10 ft																360°		85%	
📏		(ft)																📏			
ft	42.0*	42.0	55.4	68.9	82.3	95.8	109.3	122.7	136.2	149.6	162.4	175.9	190.0	203.4	216.9	230.3	255.9	ft			
	1,000 lb																				
10	490.0**	-	-	-	-	-	-	-	-	-	-	-	-	-	-	-	-	-	10		
10	286.6	286.6	286.6	286.6	248.0	-	-	-	-	-	-	-	-	-	-	-	-	-	10		
12	285.2	285.2	284.9	285.6	248.0	-	-	-	-	-	-	-	-	-	-	-	-	-	12		
14	273.4	272.8	270.6	272.7	248.0	193.1	-	-	-	-	-	-	-	-	-	-	-	-	14		
16	253.2	251.3	249.9	250.2	245.5	189.6	-	-	-	-	-	-	-	-	-	-	-	-	16		
18	233.8	232.7	232.4	232.0	231.9	188.1	154.1	-	-	-	-	-	-	-	-	-	-	-	18		
20	215.5	215.4	216.0	215.1	216.0	187.2	153.0	122.6	-	-	-	-	-	-	-	-	-	-	20		
24	190.2	188.6	188.8	189.6	188.8	179.9	149.7	119.6	97.2	-	-	-	-	-	-	-	-	-	24		
28	162.1	161.4	167.1	168.0	167.1	165.0	146.4	116.5	93.4	83.5	-	-	-	-	-	-	-	-	28		
32	108.6	108.6	148.1	148.0	147.0	145.3	143.1	112.8	90.7	81.4	71.0	-	-	-	-	-	-	-	32		
36	-	-	131.9	131.4	130.2	131.0	129.9	108.2	87.3	78.1	69.2	-	-	-	-	-	-	-	36		
40	-	-	113.9	116.3	114.9	116.5	114.7	103.4	83.6	74.4	66.8	60.2	51.0	-	-	-	-	-	40		
48	-	-	-	93.7	95.0	93.8	91.9	91.4	75.5	64.6	59.2	55.1	49.2	41.4	-	-	-	-	48		
56	-	-	-	68.6	78.8	77.5	76.6	77.4	67.8	56.4	52.3	49.3	45.6	39.5	33.6	-	-	-	56		
64	-	-	-	-	66.6	65.3	66.8	65.1	61.2	49.5	46.2	43.9	41.4	36.2	31.2	27.4	-	-	64		
72	-	-	-	-	46.0	58.1	57.5	55.8	55.9	44.2	40.7	39.3	37.1	33.1	28.7	25.2	19.2	-	72		
80	-	-	-	-	-	49.2	50.2	48.4	49.9	39.7	36.0	35.1	33.4	30.4	26.6	23.3	18.7	-	80		
88	-	-	-	-	-	12.5	44.3	44.3	43.8	35.6	32.4	31.2	30.0	27.8	24.8	21.5	18.1	-	88		
96	-	-	-	-	-	-	34.0	40.5	38.9	32.3	29.3	28.0	26.9	25.4	23.2	20.2	17.4	-	96		
104	-	-	-	-	-	-	12.0	36.4	34.7	29.2	26.8	25.1	24.3	23.2	21.8	18.9	16.4	-	104		
112	-	-	-	-	-	-	-	9.0	30.7	26.5	24.3	22.8	21.9	21.1	20.2	17.8	15.6	-	112		
120	-	-	-	-	-	-	-	-	26.3	24.2	22.3	20.8	19.8	19.2	18.6	16.6	14.7	-	120		
128	-	-	-	-	-	-	-	-	8.6	22.9	20.4	19.2	18.1	17.4	17.2	15.6	13.8	-	128		
136	-	-	-	-	-	-	-	-	-	20.5	18.7	17.6	16.6	15.8	15.7	14.6	13.0	-	136		
144	-	-	-	-	-	-	-	-	-	-	17.0	16.2	15.3	14.6	14.2	13.7	12.2	-	144		
152	-	-	-	-	-	-	-	-	-	-	-	14.8	14.0	13.3	12.9	12.9	11.1	-	152		
160	-	-	-	-	-	-	-	-	-	-	-	13.3	12.9	12.3	11.9	12.0	10.3	-	160		
168	-	-	-	-	-	-	-	-	-	-	-	-	11.7	11.4	11.1	11.0	9.5	-	168		
176	-	-	-	-	-	-	-	-	-	-	-	-	10.5	10.5	10.5	10.1	8.7	-	176		
184	-	-	-	-	-	-	-	-	-	-	-	-	-	9.9	9.8	9.1	7.9	-	184		
192	-	-	-	-	-	-	-	-	-	-	-	-	-	-	9.1	8.2	7.1	-	192		
200	-	-	-	-	-	-	-	-	-	-	-	-	-	-	8.6	7.4	6.3	-	200		
208	-	-	-	-	-	-	-	-	-	-	-	-	-	-	-	6.3	5.6	-	208		
216	-	-	-	-	-	-	-	-	-	-	-	-	-	-	-	4.9	4.9	-	216		
224	-	-	-	-	-	-	-	-	-	-	-	-	-	-	-	-	4.3	-	224		
1)	45.9	45.9	33.7	26.5	20.9	16.5	13.7	10.6	8.6	6.6	5.3	3.3	-	-	-	-	-	-	1)		

1) Capacities with horizontal boom

* over rear

** Capacity class

113,800 lb		27.60 ft x 29.10 ft																360° / Max.*		85%	
ft	360° 42.0ft	Max. 42.0ft	360° 55.4ft	Max. 55.4ft	360° 68.9ft	Max. 68.9ft	360° 82.3ft	Max. 82.3ft	360° 95.8ft	Max. 95.8ft	360° 109.3ft	Max. 109.3ft	360° 122.7ft	Max. 122.7ft	360° 136.2ft	Max. 136.2ft	ft				
1,000 lb																					
10	286.6	286.6	286.6	286.6	286.6	286.6	248.0	248.0	-	-	-	-	-	-	-	-	10				
12	284.9	285.2	284.5	284.9	284.5	285.6	248.0	248.0	-	-	-	-	-	-	-	-	12				
14	270.5	272.8	269.5	270.6	269.4	272.7	248.0	248.0	193.1	193.1	-	-	-	-	-	-	14				
16	248.8	251.3	248.8	249.9	247.7	250.2	245.5	245.5	189.6	189.6	-	-	-	-	-	-	16				
18	230.8	232.7	230.8	232.4	229.8	232.0	230.8	231.8	188.1	188.1	154.1	154.1	-	-	-	-	18				
20	213.8	215.2	213.8	215.9	214.3	214.9	213.8	215.8	187.2	187.2	153.0	153.0	122.6	122.6	-	-	20				
24	185.1	185.3	185.3	185.5	186.1	186.4	185.2	185.2	177.8	177.8	149.7	149.7	119.6	119.6	97.2	97.2	24				
28	158.1	158.1	159.4	159.4	158.9	158.9	157.8	157.8	156.1	156.1	146.4	146.4	116.5	116.5	93.4	93.4	28				
32	108.6	108.6	136.8	136.8	136.6	136.6	135.3	135.3	137.0	137.0	134.3	134.3	112.8	112.8	90.7	90.7	32				
36	-	-	119.9	119.9	119.6	119.6	118.6	118.6	120.1	120.1	118.1	118.1	108.2	108.2	87.3	87.3	36				
40	-	-	103.1	103.1	104.5	104.5	106.0	106.0	104.9	104.9	103.0	103.0	102.7	102.7	83.6	83.6	40				
48	-	-	-	-	84.5	84.5	85.3	85.3	84.1	84.1	84.4	84.4	83.9	83.9	75.5	75.5	48				
56	-	-	-	-	64.5	64.5	70.3	70.3	70.1	70.1	70.8	70.8	68.7	69.0	67.8	67.8	56				
64	-	-	-	-	-	-	57.8	59.3	59.8	60.7	58.3	59.6	56.9	57.8	57.7	59.2	64				
72	-	-	-	-	-	-	44.4	45.6	49.6	52.2	48.1	51.1	49.8	51.9	47.8	50.7	72				
80	-	-	-	-	-	-	-	-	41.7	44.4	43.4	44.3	42.4	45.6	40.3	44.0	80				
88	-	-	-	-	-	-	-	-	12.5	12.5	37.9	40.7	36.3	40.3	34.3	38.5	88				
96	-	-	-	-	-	-	-	-	-	-	32.4	33.8	31.5	35.7	29.6	33.9	96				
104	-	-	-	-	-	-	-	-	-	-	12.0	12.0	27.6	32.0	26.2	30.2	104				
112	-	-	-	-	-	-	-	-	-	-	-	-	9.0	9.0	23.6	27.0	112				
120	-	-	-	-	-	-	-	-	-	-	-	-	-	-	22.1	24.0	120				
128	-	-	-	-	-	-	-	-	-	-	-	-	-	-	8.6	8.6	128				
1)	45.9	45.9	33.7	33.7	26.5	26.5	20.9	20.9	16.5	16.5	13.7	13.7	10.6	10.6	8.6	8.6	1)				

ft	360° 149.6ft	Max. 149.6ft	360° 162.4ft	Max. 162.4ft	360° 175.9ft	Max. 175.9ft	360° 190.0ft	Max. 190.0ft	360° 203.4ft	Max. 203.4ft	360° 216.9ft	Max. 216.9ft	360° 230.3ft	Max. 230.3ft	360° 255.9ft	Max. 255.9ft	ft
1,000 lb																	
28	83.5	83.5	-	-	-	-	-	-	-	-	-	-	-	-	-	-	28
32	81.4	81.4	71.0	71.0	-	-	-	-	-	-	-	-	-	-	-	-	32
36	78.1	78.1	69.2	69.2	-	-	-	-	-	-	-	-	-	-	-	-	36
40	74.4	74.4	66.8	66.8	60.2	60.2	51.0	51.0	-	-	-	-	-	-	-	-	40
48	64.6	64.6	59.2	59.2	55.1	55.1	49.2	49.2	41.4	41.4	-	-	-	-	-	-	48
56	56.4	56.4	52.3	52.3	49.3	49.3	45.6	45.6	39.5	39.5	33.6	33.6	-	-	-	-	56
64	49.5	49.5	46.2	46.2	43.9	43.9	41.4	41.4	36.2	36.2	31.2	31.2	27.4	27.4	-	-	64
72	44.2	44.2	40.7	40.7	39.3	39.3	37.1	37.1	33.1	33.1	28.7	28.7	25.2	25.2	19.2	19.2	72
80	39.4	39.7	36.0	36.0	35.1	35.1	33.4	33.4	30.4	30.4	26.6	26.6	23.3	23.3	18.7	18.7	80
88	33.5	35.6	32.4	32.4	31.2	31.2	30.0	30.0	27.8	27.8	24.8	24.8	21.5	21.5	18.1	18.1	88
96	28.5	32.3	28.4	29.3	27.3	28.0	26.9	26.9	25.4	25.4	23.2	23.2	20.2	20.2	17.4	17.4	96
104	26.4	29.2	24.1	26.8	24.4	25.1	23.6	24.3	23.2	23.2	21.8	21.8	18.9	18.9	16.4	16.4	104
112	23.2	26.5	20.6	24.4	21.0	22.8	21.6	21.9	20.8	21.1	20.2	20.2	17.8	17.8	15.6	15.6	112
120	20.3	23.8	18.5	22.3	18.1	20.8	18.5	19.8	18.2	19.2	18.4	18.6	16.6	16.6	14.7	14.7	120
128	17.7	22.5	16.7	20.4	16.4	19.2	16.0	18.1	16.7	17.4	16.0	17.2	15.6	15.6	13.8	13.8	128
136	15.9	20.2	15.6	18.2	14.9	17.6	14.4	16.6	14.8	15.8	14.3	15.7	14.6	14.6	13.0	13.0	136
144	-	-	14.4	16.2	13.3	16.2	13.3	15.3	13.0	14.6	13.5	14.2	12.7	13.7	12.2	12.2	144
152	-	-	-	-	11.8	14.5	12.0	14.0	12.2	13.3	11.9	12.9	10.8	12.9	10.8	11.1	152
160	-	-	-	-	11.2	12.8	10.9	12.9	11.2	12.3	10.4	11.9	9.3	12.0	9.2	10.3	160
168	-	-	-	-	-	-	10.1	11.7	10.1	11.4	9.0	11.1	7.9	11.0	7.8	9.5	168
176	-	-	-	-	-	-	9.6	10.3	9.2	10.5	7.7	10.5	6.6	10.1	6.6	8.7	176
184	-	-	-	-	-	-	-	-	8.1	9.9	6.6	9.8	5.5	9.1	5.4	7.9	184
192	-	-	-	-	-	-	-	-	-	-	5.6	9.1	4.4	8.2	4.2	7.1	192
200	-	-	-	-	-	-	-	-	-	-	5.1	8.4	3.5	7.4	3.3	6.3	200
208	-	-	-	-	-	-	-	-	-	-	-	-	-	6.2	-	5.6	208
216	-	-	-	-	-	-	-	-	-	-	-	-	-	4.9	-	4.9	216
224	-	-	-	-	-	-	-	-	-	-	-	-	-	-	-	4.3	224
1)	6.6	6.4	5.3	5.3	3.3	3.3	-	-	-	-	-	-	-	-	-	-	1)

1) Capacities with horizontal boom

* Max. values are valid only for specific superstructure positions

41,200 lb		27.60 ft x 29.10 ft																360° / Max.*		85%	
ft	360° 42.0ft	Max. 42.0ft	360° 55.4ft	Max. 55.4ft	360° 68.9ft	Max. 68.9ft	360° 82.3ft	Max. 82.3ft	360° 95.8ft	Max. 95.8ft	360° 109.3ft	Max. 109.3ft	360° 122.7ft	Max. 122.7ft	360° 136.2ft	Max. 136.2ft	ft				
1,000 lb																					
10	286.6	286.6	286.6	286.6	286.6	286.6	248.0	248.0	-	-	-	-	-	-	-	-	10				
12	283.1	285.2	283.5	284.9	283.1	285.6	248.0	248.0	-	-	-	-	-	-	-	-	12				
14	265.6	271.7	266.1	270.0	265.0	271.5	248.0	248.0	193.1	193.1	-	-	-	-	-	-	14				
16	241.9	243.5	241.9	243.6	241.6	242.3	239.7	239.9	189.6	189.6	-	-	-	-	-	-	16				
18	217.5	217.5	217.5	217.7	218.7	218.9	217.5	217.5	186.4	188.1	154.1	154.1	-	-	-	-	18				
20	193.7	193.7	195.4	195.4	195.0	195.0	193.6	193.6	180.5	185.1	152.1	153.0	122.6	122.6	-	-	20				
24	156.2	156.2	157.7	157.7	157.4	157.4	155.7	156.8	147.4	157.7	133.8	146.9	118.6	119.6	97.2	97.2	24				
28	126.7	129.7	128.7	131.0	128.3	130.6	127.2	132.4	118.4	131.1	115.6	129.0	105.8	116.5	93.4	93.4	28				
32	99.6	101.8	102.6	111.4	104.8	112.6	103.3	112.5	101.7	111.4	96.3	111.4	92.6	109.5	86.2	90.7	32				
36	-	-	85.1	97.3	85.9	99.0	85.3	98.4	86.7	97.2	82.3	99.0	81.5	97.1	74.8	87.3	36				
40	-	-	70.6	85.7	70.0	86.3	72.8	85.8	71.9	87.6	74.3	86.3	69.8	84.5	65.5	83.0	40				
48	-	-	-	-	52.7	69.0	52.8	69.7	55.4	70.1	54.3	69.0	52.4	70.0	50.9	67.7	48				
56	-	-	-	-	41.6	56.8	42.6	58.3	42.2	57.7	41.3	57.9	40.6	58.0	39.3	54.0	56				
64	-	-	-	-	-	-	33.6	49.1	33.3	48.4	32.3	50.0	33.1	48.7	32.4	45.3	64				
72	-	-	-	-	-	-	27.2	40.8	26.8	42.9	27.6	41.8	27.5	40.1	26.1	37.7	72				
80	-	-	-	-	-	-	-	-	23.0	35.4	23.6	34.3	22.7	32.8	21.8	32.1	80				
88	-	-	-	-	-	-	-	-	12.5	12.5	19.9	28.6	18.7	27.4	18.9	27.5	88				
96	-	-	-	-	-	-	-	-	-	-	16.8	24.2	16.2	24.1	16.3	24.2	96				
104	-	-	-	-	-	-	-	-	-	-	12.0	12.0	14.7	21.7	13.7	20.3	104				
112	-	-	-	-	-	-	-	-	-	-	-	-	9.0	9.0	11.7	17.3	112				
120	-	-	-	-	-	-	-	-	-	-	-	-	-	-	10.8	15.1	120				
128	-	-	-	-	-	-	-	-	-	-	-	-	-	-	8.6	8.6	128				
1)	45.9	45.9	33.7	33.7	26.5	26.5	20.9	20.9	16.5	16.5	13.7	13.7	10.6	10.6	8.6	8.6	1)				

360° / Max.*		27.60 ft x 29.10 ft																360° / Max.*		85%	
ft	360° 149.6ft	Max. 149.6ft	360° 162.4ft	Max. 162.4ft	360° 175.9ft	Max. 175.9ft	360° 190.0ft	Max. 190.0ft	360° 203.4ft	Max. 203.4ft	360° 216.9ft	Max. 216.9ft	360° 230.3ft	Max. 230.3ft	360° 255.9ft	Max. 255.9ft	ft				
1,000 lb																					
28	83.5	83.5	-	-	-	-	-	-	-	-	-	-	-	-	-	-	28				
32	80.1	81.4	71.0	71.0	-	-	-	-	-	-	-	-	-	-	-	-	32				
36	70.5	78.1	64.2	69.2	-	-	-	-	-	-	-	-	-	-	-	-	36				
40	62.9	74.4	57.5	66.8	55.6	60.2	50.3	51.0	-	-	-	-	-	-	-	-	40				
48	48.1	63.1	46.9	58.1	43.6	54.4	42.3	49.2	39.4	41.4	-	-	-	-	-	-	48				
56	38.9	50.6	37.4	48.2	36.5	45.7	33.0	43.6	32.6	39.5	31.2	33.6	-	-	-	-	56				
64	31.7	42.4	31.0	39.3	29.1	38.4	29.1	36.6	26.6	35.2	26.6	31.2	25.2	27.4	-	-	64				
72	25.9	36.1	25.6	34.7	25.6	32.0	24.1	31.2	23.9	29.2	21.9	28.7	20.2	25.2	19.0	19.2	72				
80	22.0	30.9	21.8	29.4	20.9	28.9	21.3	26.0	20.4	25.7	19.3	24.5	16.2	23.3	14.9	18.7	80				
88	18.6	26.7	17.8	24.8	18.5	24.7	17.8	23.0	17.5	22.3	15.9	21.2	12.8	20.9	11.6	18.1	88				
96	15.4	22.2	16.1	22.4	15.7	20.9	15.5	20.9	14.8	19.0	12.9	19.1	9.9	17.7	8.8	16.5	96				
104	14.0	19.0	13.8	19.2	13.1	18.7	13.1	18.2	12.0	17.6	10.4	16.4	7.5	15.7	6.4	13.8	104				
112	12.2	17.1	11.6	16.2	11.8	16.8	10.9	16.0	9.8	16.2	8.5	14.7	5.6	13.3	4.5	11.3	112				
120	10.4	15.5	10.0	14.8	9.9	14.3	9.0	14.5	7.9	14.1	6.7	13.2	3.8	11.2	-	9.2	120				
128	8.7	13.3	8.9	13.1	8.3	12.9	7.4	13.0	6.3	12.1	5.1	11.2	-	9.1	-	7.3	128				
136	7.4	11.8	7.6	11.4	6.9	11.9	5.9	11.0	4.9	11.0	3.6	9.5	-	7.6	-	5.8	136				
144	-	-	6.4	10.4	5.6	10.4	4.7	9.5	3.6	9.6	2.5	8.0	-	6.2	-	4.5	144				
152	-	-	-	-	4.5	9.1	3.6	8.7	-	8.2	-	6.9	-	4.9	-	3.4	152				
160	-	-	-	-	3.5	7.8	-	7.8	-	6.9	-	5.6	-	3.9	-	-	160				
168	-	-	-	-	-	-	-	6.8	-	5.7	-	4.6	-	-	-	-	168				
176	-	-	-	-	-	-	-	5.9	-	4.8	-	3.7	-	-	-	-	176				
184	-	-	-	-	-	-	-	-	-	3.9	-	2.8	-	-	-	-	184				
1)	6.6	6.4	5.3	5.3	2.9	3.3	-	-	-	-	-	-	-	-	-	-	1)				

1) Capacities with horizontal boom
 * Max. values are valid only for specific superstructure positions

0 lb		27.60 ft x 29.10 ft																360° / Max.*		85%																
		360°		Max.		360°		Max.		360°		Max.		360°		Max.		360°		Max.																
		42.0ft		42.0ft		55.4ft		55.4ft		68.9ft		68.9ft		82.3ft		82.3ft		95.8ft		95.8ft		109.3ft		109.3ft		122.7ft		122.7ft		136.2ft		136.2ft				
ft		1,000 lb																								ft										
10		286.6	286.6	286.6	286.6	286.6	286.6	286.6	286.6	248.0	248.0	-	-	-	-	-	-	-	-	-	-	-	-	-	-	-	-	-	-	-	-	10				
12		281.7	282.0	282.1	282.1	281.4	281.6	248.0	248.0	-	-	-	-	-	-	-	-	-	-	-	-	-	-	-	-	-	-	-	-	-	-	-	12			
14		255.9	256.6	256.4	256.7	253.1	255.4	227.1	245.4	192.7	193.1	-	-	-	-	-	-	-	-	-	-	-	-	-	-	-	-	-	-	-	-	-	14			
16		222.1	222.2	224.1	224.1	207.9	223.7	187.4	222.2	168.8	189.6	-	-	-	-	-	-	-	-	-	-	-	-	-	-	-	-	-	-	-	-	-	-	16		
18		194.2	194.7	188.3	196.4	170.8	196.1	158.7	194.6	141.5	182.0	131.9	154.1	-	-	-	-	-	-	-	-	-	-	-	-	-	-	-	-	-	-	-	-	18		
20		166.8	170.0	153.8	171.6	144.5	171.3	131.6	173.3	124.9	171.8	112.2	151.4	107.6	122.6	-	-	-	-	-	-	-	-	-	-	-	-	-	-	-	-	-	-	20		
24		109.2	136.7	111.6	138.3	104.4	139.0	100.9	139.7	95.0	137.2	90.3	127.2	83.3	112.3	75.9	97.2	-	-	-	-	-	-	-	-	-	-	-	-	-	-	-	-	24		
28		74.0	113.2	82.0	115.6	82.2	116.4	79.2	115.9	76.8	110.5	70.9	101.8	65.7	95.3	62.3	86.3	-	-	-	-	-	-	-	-	-	-	-	-	-	-	-	-	28		
32		53.1	95.8	61.6	98.4	63.3	98.9	65.5	95.3	61.6	91.3	56.9	86.1	54.2	78.7	51.6	71.6	-	-	-	-	-	-	-	-	-	-	-	-	-	-	-	-	32		
36		-	-	48.6	85.5	52.0	83.6	53.2	80.9	51.0	75.0	48.8	73.3	47.1	65.4	44.3	60.3	-	-	-	-	-	-	-	-	-	-	-	-	-	-	-	-	36		
40		-	-	38.0	72.7	41.0	69.7	42.1	67.1	41.7	66.3	43.1	60.3	39.9	55.3	36.9	52.1	-	-	-	-	-	-	-	-	-	-	-	-	-	-	-	-	40		
48		-	-	-	-	29.4	48.8	30.0	50.9	31.5	47.9	31.1	44.2	29.6	42.4	29.7	40.3	-	-	-	-	-	-	-	-	-	-	-	-	-	-	-	-	-	48	
56		-	-	-	-	21.3	36.3	22.8	37.0	23.3	36.6	23.4	34.8	23.8	35.2	23.2	32.5	-	-	-	-	-	-	-	-	-	-	-	-	-	-	-	-	-	56	
64		-	-	-	-	-	-	17.4	28.8	18.0	28.4	18.5	29.6	18.4	28.8	18.4	26.5	-	-	-	-	-	-	-	-	-	-	-	-	-	-	-	-	-	64	
72		-	-	-	-	-	-	13.1	22.8	14.4	24.5	14.6	24.2	14.8	23.3	14.4	22.8	-	-	-	-	-	-	-	-	-	-	-	-	-	-	-	-	-	72	
80		-	-	-	-	-	-	-	-	11.3	20.2	11.3	19.7	11.7	19.1	11.0	19.7	-	-	-	-	-	-	-	-	-	-	-	-	-	-	-	-	-	80	
88		-	-	-	-	-	-	-	-	8.7	12.5	8.7	16.3	9.0	17.1	8.4	16.1	-	-	-	-	-	-	-	-	-	-	-	-	-	-	-	-	-	88	
96		-	-	-	-	-	-	-	-	-	-	6.5	14.5	6.8	14.3	6.3	13.9	-	-	-	-	-	-	-	-	-	-	-	-	-	-	-	-	-	96	
104		-	-	-	-	-	-	-	-	-	-	5.0	12.0	5.0	11.8	4.6	11.9	-	-	-	-	-	-	-	-	-	-	-	-	-	-	-	-	-	104	
112		-	-	-	-	-	-	-	-	-	-	-	-	3.7	9.0	-	10.1	-	-	-	-	-	-	-	-	-	-	-	-	-	-	-	-	-	112	
120		-	-	-	-	-	-	-	-	-	-	-	-	-	-	-	8.7	-	-	-	-	-	-	-	-	-	-	-	-	-	-	-	-	-	120	
128		-	-	-	-	-	-	-	-	-	-	-	-	-	-	-	7.2	-	-	-	-	-	-	-	-	-	-	-	-	-	-	-	-	-	-	128
1)		45.9	45.9	27.3	33.7	18.1	26.5	12.3	20.9	8.6	16.5	5.3	13.4	3.1	10.1	-	7.1	-	-	-	-	-	-	-	-	-	-	-	-	-	-	-	-	-	1)	

		360°		Max.		360°		Max.		360°		Max.		360°		Max.		360°		Max.		360°		Max.		360°		Max.							
		149.6ft		149.6ft		162.4ft		162.4ft		175.9ft		175.9ft		190.0ft		190.0ft		203.4ft		203.4ft		216.9ft		216.9ft		230.3ft		230.3ft		255.9ft		255.9ft			
ft		1,000 lb																								ft									
28		55.5	75.8	-	-	-	-	-	-	-	-	-	-	-	-	-	-	-	-	-	-	-	-	-	-	-	-	-	-	-	-	-	-	28	
32		49.0	65.8	43.9	56.0	-	-	-	-	-	-	-	-	-	-	-	-	-	-	-	-	-	-	-	-	-	-	-	-	-	-	-	-	-	32
36		41.2	56.3	40.4	52.0	-	-	-	-	-	-	-	-	-	-	-	-	-	-	-	-	-	-	-	-	-	-	-	-	-	-	-	-	-	36
40		36.7	47.1	34.6	45.9	34.5	42.4	31.5	40.2	-	-	-	-	-	-	-	-	-	-	-	-	-	-	-	-	-	-	-	-	-	-	-	-	-	40
48		28.6	38.7	27.7	35.5	26.5	34.6	24.8	32.6	22.4	31.5	-	-	-	-	-	-	-	-	-	-	-	-	-	-	-	-	-	-	-	-	-	-	-	48
56		22.9	30.7	22.1	30.4	21.0	28.0	18.9	27.6	16.8	25.6	14.3	23.3	-	-	-	-	-	-	-	-	-	-	-	-	-	-	-	-	-	-	-	-	-	56
64		17.7	26.2	17.8	24.7	16.3	24.6	14.3	22.6	12.3	21.6	9.7	19.2	-	16.5	-	-	-	-	-	-	-	-	-	-	-	-	-	-	-	-	-	-	-	64
72		13.3	21.7	14.0	21.2	12.4	20.6	10.4	19.7	8.5	17.7	6.0	15.3	-	12.9	-	10.7	-	-	-	-	-	-	-	-	-	-	-	-	-	-	-	-	-	72
80		10.2	18.4	10.6	18.7	9.3	17.4	7.6	16.3	5.6	14.5	-	12.3	-	9.9	-	7.3	-	-	-	-	-	-	-	-	-	-	-	-	-	-	-	-	-	80
88		7.6	16.5	8.0	15.6	6.8	15.4	5.2	13.5	3.5	11.8	-	9.5	-	7.1	-	4.8	-	-	-	-	-	-	-	-	-	-	-	-	-	-	-	-	-	88
96		5.4	14.0	5.9	13.3	4.9	12.9	3.4	11.1	-	9.3	-	7.1	-	4.8	-	2.8	-	-	-	-	-	-	-	-	-	-	-	-	-	-	-	-	-	96
104		3.7	11.5	4.2	11.9	3.3	10.6	-	9.1	-	7.3	-	5.1	-	3.1	-	-	-	-	-	-	-	-	-	-	-	-	-	-	-	-	-	-	-	104
112		-	9.6	-	9.8	-	8.7	-	7.2	-	5.6	-	3.5	-	-	-	-	-	-	-	-	-	-	-	-	-	-	-	-	-	-	-	-	-	112
120		-	8.0	-	8.2	-	7.3	-	5.6	-	4.1	-	-	-	-	-	-	-	-	-	-	-	-	-	-	-	-	-	-	-	-	-	-	-	120
128		-	6.5	-	6.7	-	5.9	-	4.4	-	2.9	-	-	-	-	-	-	-	-	-	-	-	-	-	-	-	-	-	-	-	-	-	-	-	128
136		-	5.3	-	5.5	-	4.7	-	3.3	-	-	-	-	-	-	-	-	-	-	-	-	-	-	-	-	-	-	-	-	-	-	-	-	-	136
144		-	-	-	4.5	-	3.6	-	2.5	-	-	-	-	-	-	-	-	-	-	-	-	-	-	-	-	-	-	-	-	-	-	-	-	-	144
1)		-	4.6	-	3.3	-	-	-	-	-	-	-	-	-	-	-	-	-	-	-	-	-	-	-	-	-	-	-	-	-	-	-	-	-	1)

1) Capacities with horizontal boom

* Max. values are valid only for specific superstructure positions

154,800 lb		23.00 ft x 29.10 ft																360° / Max.*				85%	
ft		360° 42.0ft	Max. 42.0ft	360° 55.4ft	Max. 55.4ft	360° 68.9ft	Max. 68.9ft	360° 82.3ft	Max. 82.3ft	360° 95.8ft	Max. 95.8ft	360° 109.3ft	Max. 109.3ft	360° 122.7ft	Max. 122.7ft	360° 136.2ft	Max. 136.2ft	ft					
ft		1,000 lb																ft					
10		286.6	286.6	286.6	286.6	286.6	286.6	248.0	248.0	-	-	-	-	-	-	-	-	-	10				
12		282.8	285.2	282.8	284.9	282.4	285.6	248.0	248.0	-	-	-	-	-	-	-	-	-	12				
14		263.9	272.8	263.9	270.6	262.8	272.7	248.0	248.0	193.1	193.1	-	-	-	-	-	-	-	14				
16		241.3	251.3	241.3	249.9	241.6	250.2	239.7	245.5	189.6	189.6	-	-	-	-	-	-	-	16				
18		222.7	232.7	222.9	232.4	224.0	232.0	222.9	231.8	188.1	188.1	154.1	154.1	-	-	-	-	-	18				
20		205.5	215.4	205.7	216.0	206.8	215.1	205.7	216.0	187.2	187.2	153.0	153.0	122.6	122.6	-	-	-	20				
24		178.6	188.6	179.9	188.8	179.7	189.6	178.8	188.8	177.1	179.9	149.7	149.7	119.6	119.6	97.2	97.2	-	24				
28		156.7	161.4	158.5	167.1	158.3	168.0	157.3	167.1	156.8	165.0	146.4	146.4	116.5	116.5	93.4	93.4	-	28				
32		108.6	108.7	141.1	148.1	141.0	148.0	139.9	147.0	141.5	145.3	138.7	143.1	112.8	112.8	90.7	90.7	-	32				
36		-	-	123.1	131.9	123.0	131.4	121.7	130.2	123.3	131.0	121.5	129.9	108.2	108.2	87.3	87.3	-	36				
40		-	-	103.9	113.9	105.1	116.2	106.9	114.9	105.4	116.5	103.2	114.7	102.4	103.4	83.6	83.6	-	40				
48		-	-	-	-	81.2	93.5	80.8	94.8	79.4	93.7	81.2	91.9	79.2	91.4	75.2	75.2	-	48				
56		-	-	-	-	61.6	68.5	63.8	78.5	65.4	77.5	64.2	76.6	63.1	77.3	63.9	63.9	-	56				
64		-	-	-	-	-	-	53.8	66.5	53.3	65.3	52.6	66.8	53.8	65.1	51.9	51.9	-	64				
72		-	-	-	-	-	-	44.3	45.8	44.5	57.9	46.0	56.7	44.7	54.5	43.2	43.2	-	72				
80		-	-	-	-	-	-	-	-	39.6	47.7	39.5	48.3	38.2	47.9	36.6	36.6	-	80				
88		-	-	-	-	-	-	-	-	12.5	12.5	34.2	41.7	33.1	43.2	32.2	32.2	-	88				
96		-	-	-	-	-	-	-	-	-	-	30.0	34.0	28.8	37.8	27.9	27.9	-	96				
104		-	-	-	-	-	-	-	-	-	-	12.0	12.0	25.3	33.4	24.9	24.9	-	104				
112		-	-	-	-	-	-	-	-	-	-	-	-	9.0	9.0	23.0	23.0	-	112				
120		-	-	-	-	-	-	-	-	-	-	-	-	-	-	20.9	20.9	-	120				
128		-	-	-	-	-	-	-	-	-	-	-	-	-	-	8.6	8.6	-	128				
1)		45.9	45.9	33.7	33.7	26.5	26.5	20.9	20.9	16.5	16.5	13.7	13.7	10.6	10.6	8.6	8.6	-	1)				

ft		360° 149.6ft	Max. 149.6ft	360° 162.4ft	Max. 162.4ft	360° 175.9ft	Max. 175.9ft	360° 190.0ft	Max. 190.0ft	360° 203.4ft	Max. 203.4ft	360° 216.9ft	Max. 216.9ft	360° 230.3ft	Max. 230.3ft	360° 255.9ft	Max. 255.9ft	ft		
ft		1,000 lb																ft		
28		83.5	83.5	-	-	-	-	-	-	-	-	-	-	-	-	-	-	-	-	28
32		81.4	81.4	71.0	71.0	-	-	-	-	-	-	-	-	-	-	-	-	-	-	32
36		78.1	78.1	69.2	69.2	-	-	-	-	-	-	-	-	-	-	-	-	-	-	36
40		74.4	74.4	66.8	66.8	60.2	60.2	51.0	51.0	-	-	-	-	-	-	-	-	-	-	40
48		64.6	64.6	59.2	59.2	55.1	55.1	49.2	49.2	41.4	41.4	-	-	-	-	-	-	-	-	48
56		56.4	56.4	52.3	52.3	49.3	49.3	45.6	45.6	39.5	39.5	33.6	33.6	-	-	-	-	-	-	56
64		49.5	49.5	46.2	46.2	43.9	43.9	41.4	41.4	36.2	36.2	31.2	31.2	27.4	27.4	-	-	-	-	64
72		42.5	44.2	40.7	40.7	39.3	39.3	37.1	37.1	33.1	33.1	28.7	28.7	25.2	25.2	19.2	19.2	-	-	72
80		35.9	39.7	35.6	36.0	34.9	35.1	33.4	33.4	30.4	30.4	26.6	26.6	23.3	23.3	18.7	18.7	-	-	80
88		30.6	35.6	30.6	32.4	30.2	31.2	29.8	30.0	27.8	27.8	24.8	24.8	21.5	21.5	18.1	18.1	-	-	88
96		27.9	32.3	26.4	29.3	26.7	28.0	25.9	26.9	25.4	25.4	23.2	23.2	20.2	20.2	17.4	17.4	-	-	96
104		24.7	29.2	22.9	26.8	23.1	25.1	23.4	24.3	22.8	23.2	21.8	21.8	18.9	18.9	16.4	16.4	-	-	104
112		21.7	26.5	20.4	24.4	20.1	22.8	20.6	21.9	20.1	21.1	20.2	20.2	17.8	17.8	15.6	15.6	-	-	112
120		19.3	23.8	18.5	22.3	18.1	20.8	18.2	19.8	18.2	19.2	18.2	18.6	16.6	16.6	14.7	14.7	-	-	120
128		17.5	22.6	16.6	20.4	16.4	19.2	16.0	18.1	16.6	17.4	16.0	17.2	15.6	15.6	13.8	13.8	-	-	128
136		15.6	20.3	15.6	18.2	14.9	17.6	14.4	16.6	14.8	15.8	14.3	15.7	14.6	14.6	13.0	13.0	-	-	136
144		-	-	14.4	16.2	13.5	16.2	13.3	15.3	13.1	14.6	13.5	14.2	13.1	13.7	12.2	12.2	-	-	144
152		-	-	-	-	12.2	14.5	12.0	14.0	12.2	13.3	12.4	12.9	11.7	12.9	11.1	11.1	-	-	152
160		-	-	-	-	11.2	12.8	11.0	12.9	11.4	12.3	11.0	11.9	10.4	12.0	10.2	10.3	-	-	160
168		-	-	-	-	-	-	10.2	11.7	10.5	11.4	9.8	11.1	9.2	11.0	9.2	9.5	-	-	168
176		-	-	-	-	-	-	9.6	10.3	9.6	10.5	8.8	10.5	8.1	10.1	8.1	8.7	-	-	176
184		-	-	-	-	-	-	-	-	8.8	9.9	7.8	9.8	7.0	9.1	6.9	7.9	-	-	184
192		-	-	-	-	-	-	-	-	-	-	6.9	9.1	6.0	8.2	5.8	7.1	-	-	192
200		-	-	-	-	-	-	-	-	-	-	6.1	8.4	5.0	7.4	5.0	6.3	-	-	200
208		-	-	-	-	-	-	-	-	-	-	-	-	4.2	6.2	4.2	5.6	-	-	208
216		-	-	-	-	-	-	-	-	-	-	-	-	3.6	4.9	3.4	4.9	-	-	216
224		-	-	-	-	-	-	-	-	-	-	-	-	-	-	4.3	4.3	-	-	224
1)		6.6	6.6	5.3	5.3	3.3	3.3	-	-	-	-	-	-	-	-	-	-	-	-	1)

1) Capacities with horizontal boom

* Max. values are valid only for specific superstructure positions

113,800 lb		23.00 ft x 29.10 ft																360° / Max.*		85%	
ft	360° 42.0ft	Max. 42.0ft	360° 55.4ft	Max. 55.4ft	360° 68.9ft	Max. 68.9ft	360° 82.3ft	Max. 82.3ft	360° 95.8ft	Max. 95.8ft	360° 109.3ft	Max. 109.3ft	360° 122.7ft	Max. 122.7ft	360° 136.2ft	Max. 136.2ft	ft				
1,000 lb																					
10	286.6	286.6	286.6	286.6	286.6	286.6	248.0	248.0	-	-	-	-	-	-	-	-	10				
12	281.0	285.2	281.0	284.9	280.7	285.6	248.0	248.0	-	-	-	-	-	-	-	-	12				
14	258.4	272.8	258.4	270.6	258.4	272.7	248.0	248.0	193.1	193.1	-	-	-	-	-	-	14				
16	236.7	251.3	236.7	249.9	236.9	250.2	236.4	245.5	189.6	189.6	-	-	-	-	-	-	16				
18	218.7	232.7	218.8	232.4	219.2	232.0	218.8	231.8	188.1	188.1	154.1	154.1	-	-	-	-	18				
20	201.7	215.2	203.1	215.9	202.9	214.9	201.9	215.8	186.9	187.2	153.0	153.0	122.6	122.6	-	-	20				
24	175.3	185.3	176.6	185.5	176.4	186.4	175.4	185.1	171.6	177.8	149.5	149.7	119.6	119.6	97.2	97.2	24				
28	147.9	157.8	149.6	159.2	149.3	158.9	148.0	157.6	148.6	156.1	136.3	146.4	116.5	116.5	93.4	93.4	28				
32	105.2	108.6	119.5	136.8	119.3	136.4	121.2	135.1	119.7	136.8	115.0	134.1	110.3	112.8	90.7	90.7	32				
36	-	-	99.1	119.8	99.9	119.5	100.7	118.6	99.2	119.8	98.2	118.0	96.5	108.2	87.3	87.3	36				
40	-	-	83.3	102.9	83.7	104.5	83.3	106.0	85.3	104.7	83.9	103.0	81.8	102.7	82.5	83.6	40				
48	-	-	-	-	62.8	84.5	64.7	85.2	64.0	83.9	64.3	84.3	64.5	83.9	62.5	75.5	48				
56	-	-	-	-	51.0	64.4	50.8	70.3	51.8	70.0	51.9	70.7	50.6	69.0	49.6	67.8	56				
64	-	-	-	-	-	-	41.9	59.3	43.0	60.7	42.1	59.6	41.0	57.8	40.3	59.2	64				
72	-	-	-	-	-	-	36.1	45.6	35.6	52.2	35.0	51.1	34.0	51.9	33.4	50.7	72				
80	-	-	-	-	-	-	-	-	30.4	44.4	29.7	44.3	29.1	45.6	29.7	44.0	80				
88	-	-	-	-	-	-	-	-	12.5	12.5	25.4	40.7	25.7	40.3	25.4	38.5	88				
96	-	-	-	-	-	-	-	-	-	-	22.4	33.8	23.2	35.7	21.9	33.9	96				
104	-	-	-	-	-	-	-	-	-	-	12.0	12.0	20.4	32.0	19.1	30.2	104				
112	-	-	-	-	-	-	-	-	-	-	-	-	9.0	9.0	16.9	27.0	112				
120	-	-	-	-	-	-	-	-	-	-	-	-	-	-	15.2	24.0	120				
128	-	-	-	-	-	-	-	-	-	-	-	-	-	-	8.6	8.6	128				
1)	45.9	45.9	33.7	33.7	26.5	26.5	20.9	20.9	16.5	16.5	13.7	13.7	10.6	10.6	8.6	8.6	1)				

ft	360° 149.6ft	Max. 149.6ft	360° 162.4ft	Max. 162.4ft	360° 175.9ft	Max. 175.9ft	360° 190.0ft	Max. 190.0ft	360° 203.4ft	Max. 203.4ft	360° 216.9ft	Max. 216.9ft	360° 230.3ft	Max. 230.3ft	360° 255.9ft	Max. 255.9ft	ft
1,000 lb																	
28	83.5	83.5	-	-	-	-	-	-	-	-	-	-	-	-	-	-	28
32	81.4	81.4	71.0	71.0	-	-	-	-	-	-	-	-	-	-	-	-	32
36	78.1	78.1	69.2	69.2	-	-	-	-	-	-	-	-	-	-	-	-	36
40	74.2	74.4	66.8	66.8	60.2	60.2	51.0	51.0	-	-	-	-	-	-	-	-	40
48	61.2	64.6	58.2	59.2	55.1	55.1	49.2	49.2	41.4	41.4	-	-	-	-	-	-	48
56	48.1	56.4	48.0	52.3	47.0	49.3	45.0	45.6	39.5	39.5	33.6	33.6	-	-	-	-	56
64	39.9	49.5	39.3	46.2	38.8	43.9	37.8	41.4	36.2	36.2	31.2	31.2	27.4	27.4	-	-	64
72	33.4	44.2	33.0	40.7	32.0	39.3	32.1	37.1	31.4	33.1	28.7	28.7	25.2	25.2	19.2	19.2	72
80	28.2	39.7	27.7	36.0	28.0	35.1	26.8	33.4	26.2	30.4	26.3	26.6	23.3	23.3	18.7	18.7	80
88	24.1	35.6	24.4	32.4	23.9	31.2	23.0	30.0	23.4	27.8	22.6	24.8	21.5	21.5	18.1	18.1	88
96	20.9	32.3	21.0	29.3	20.4	28.0	20.8	26.9	19.9	25.4	19.8	23.2	19.6	20.2	17.4	17.4	96
104	19.0	29.2	18.2	26.8	18.7	25.1	18.2	24.3	17.6	23.2	17.7	21.8	17.1	18.9	16.4	16.4	104
112	16.9	26.5	16.2	24.4	16.4	22.8	16.0	21.9	16.2	21.1	15.3	20.2	14.6	17.8	14.6	15.6	112
120	15.4	23.8	14.9	22.3	14.5	20.8	14.6	19.8	14.5	19.2	13.6	18.6	12.6	16.6	12.6	14.7	120
128	13.7	22.5	13.4	20.4	12.9	19.2	13.4	18.1	12.8	17.4	12.4	17.2	11.0	15.6	10.8	13.8	128
136	12.2	20.2	12.0	18.2	12.1	17.6	11.8	16.6	11.2	15.8	11.1	15.7	9.4	14.6	9.3	13.0	136
144	-	-	10.8	16.2	11.1	16.2	10.4	15.3	10.2	14.6	9.8	14.2	8.0	13.7	8.0	12.2	144
152	-	-	-	-	10.0	14.5	9.3	14.0	9.3	13.3	8.7	12.9	6.7	12.9	6.5	11.1	152
160	-	-	-	-	9.0	12.8	8.3	12.9	8.3	12.3	7.6	11.9	5.4	12.0	5.3	10.3	160
168	-	-	-	-	-	-	7.4	11.7	7.5	11.4	6.5	11.1	4.3	11.0	4.2	9.5	168
176	-	-	-	-	-	-	6.7	10.3	6.5	10.5	5.4	10.5	3.2	10.1	3.2	8.7	176
184	-	-	-	-	-	-	-	-	5.7	9.9	4.6	9.8	-	9.1	-	7.9	184
192	-	-	-	-	-	-	-	-	-	-	3.8	9.1	-	8.2	-	7.1	192
200	-	-	-	-	-	-	-	-	-	-	3.0	8.4	-	7.4	-	6.3	200
208	-	-	-	-	-	-	-	-	-	-	-	-	-	6.2	-	5.6	208
216	-	-	-	-	-	-	-	-	-	-	-	-	-	4.9	-	4.9	216
224	-	-	-	-	-	-	-	-	-	-	-	-	-	-	-	4.3	224
1)	6.6	6.6	5.3	5.3	3.3	3.3	-	-	-	-	-	-	-	-	-	-	1)

1) Capacities with horizontal boom

* Max. values are valid only for specific superstructure positions

41,200 lb		23.00 ft x 29.10 ft																360° / Max.*		85%	
ft	360° 42.0ft	Max. 42.0ft	360° 55.4ft	Max. 55.4ft	360° 68.9ft	Max. 68.9ft	360° 82.3ft	Max. 82.3ft	360° 95.8ft	Max. 95.8ft	360° 109.3ft	Max. 109.3ft	360° 122.7ft	Max. 122.7ft	360° 136.2ft	Max. 136.2ft	ft				
1,000 lb																					
10	286.2	286.6	286.2	286.6	286.2	286.6	248.0	248.0	-	-	-	-	-	-	-	-	10				
12	275.2	285.2	275.2	284.9	275.6	285.6	248.0	248.0	-	-	-	-	-	-	-	-	12				
14	250.1	271.7	251.2	270.0	251.2	271.5	227.8	248.0	191.8	193.1	-	-	-	-	-	-	14				
16	228.9	243.5	230.0	243.6	214.7	242.3	190.7	239.9	169.6	189.6	-	-	-	-	-	-	16				
18	200.8	217.5	199.8	217.7	180.0	218.9	164.3	217.5	145.2	188.1	134.4	154.1	-	-	-	-	18				
20	170.0	193.5	167.5	195.2	154.6	195.0	138.8	193.5	130.7	185.1	117.6	153.0	112.1	122.6	-	-	20				
24	111.1	156.0	115.9	157.5	115.2	157.3	111.5	156.8	102.3	157.7	98.7	146.9	89.8	119.6	83.6	97.2	24				
28	80.0	129.7	85.5	131.0	86.1	130.6	87.5	132.4	86.5	131.1	80.9	129.0	75.3	116.5	69.3	93.4	28				
32	61.2	101.8	66.6	111.4	67.8	112.6	69.7	112.5	70.5	111.4	67.9	111.4	63.5	105.2	60.2	90.7	32				
36	-	-	55.0	97.3	56.8	99.0	58.3	98.4	58.1	97.2	56.9	98.7	54.4	89.1	52.4	82.9	36				
40	-	-	44.8	85.7	47.0	86.3	47.8	85.8	47.6	87.6	46.8	85.4	47.0	80.2	45.8	73.8	40				
48	-	-	-	-	34.4	68.3	35.0	69.3	34.8	69.5	36.5	65.6	35.6	63.7	34.8	59.3	48				
56	-	-	-	-	27.0	52.9	27.0	54.9	28.5	53.9	28.1	55.3	27.3	51.2	27.3	47.1	56				
64	-	-	-	-	-	-	22.4	42.5	22.6	44.4	22.3	43.5	22.8	41.5	22.2	39.5	64				
72	-	-	-	-	-	-	18.4	36.3	18.4	35.9	19.0	35.0	18.6	34.0	18.8	32.5	72				
80	-	-	-	-	-	-	-	-	15.3	29.9	15.9	29.0	15.5	28.3	15.5	28.6	80				
88	-	-	-	-	-	-	-	-	12.5	12.5	13.5	24.4	13.3	25.3	13.1	24.3	88				
96	-	-	-	-	-	-	-	-	-	-	11.4	22.2	11.2	21.9	11.2	20.6	96				
104	-	-	-	-	-	-	-	-	-	-	9.7	12.0	9.8	18.9	9.5	17.8	104				
112	-	-	-	-	-	-	-	-	-	-	-	-	8.3	9.0	8.1	15.6	112				
120	-	-	-	-	-	-	-	-	-	-	-	-	-	-	6.8	14.5	120				
128	-	-	-	-	-	-	-	-	-	-	-	-	-	-	5.8	8.6	128				
1)	45.9	45.9	33.7	33.7	23.8	26.5	17.6	20.9	13.4	16.5	10.4	13.7	7.9	10.6	5.7	8.6	1)				

41,200 lb		23.00 ft x 29.10 ft																360° / Max.*		85%	
ft	360° 149.6ft	Max. 149.6ft	360° 162.4ft	Max. 162.4ft	360° 175.9ft	Max. 175.9ft	360° 190.0ft	Max. 190.0ft	360° 203.4ft	Max. 203.4ft	360° 216.9ft	Max. 216.9ft	360° 230.3ft	Max. 230.3ft	360° 255.9ft	Max. 255.9ft	ft				
1,000 lb																					
28	63.2	83.5	-	-	-	-	-	-	-	-	-	-	-	-	-	-	28				
32	55.9	81.4	47.4	71.0	-	-	-	-	-	-	-	-	-	-	-	-	32				
36	49.0	75.8	47.1	68.5	-	-	-	-	-	-	-	-	-	-	-	-	36				
40	44.1	69.1	40.7	64.8	39.5	59.6	37.5	50.9	-	-	-	-	-	-	-	-	40				
48	34.0	54.8	33.9	50.6	31.7	48.7	31.3	45.6	29.4	40.8	-	-	-	-	-	-	48				
56	27.3	44.5	26.6	42.9	26.8	39.4	25.4	38.4	24.6	35.8	22.1	33.4	-	-	-	-	56				
64	22.5	37.7	22.4	34.9	21.8	34.0	21.5	31.2	20.0	30.6	17.8	29.1	14.7	27.4	-	-	64				
72	18.6	31.7	18.1	30.3	18.2	28.8	17.5	27.2	16.4	25.7	14.4	24.7	11.3	24.1	10.2	19.2	72				
80	15.2	26.4	15.7	26.4	15.0	24.5	14.3	24.5	13.5	22.4	11.5	21.7	8.7	19.9	7.8	18.3	80				
88	12.7	23.0	13.1	22.0	12.4	21.9	11.8	20.9	11.0	20.4	9.2	18.5	6.3	17.4	5.5	15.3	88				
96	10.7	20.4	10.9	19.3	10.3	19.1	9.7	18.0	8.9	18.1	7.2	16.9	4.5	15.0	3.8	12.8	96				
104	8.8	18.0	9.2	17.6	8.6	16.2	7.9	16.7	7.3	15.5	5.5	14.7	2.8	12.6	-	10.4	104				
112	7.4	15.5	7.7	15.3	7.2	14.9	6.5	14.4	5.7	13.8	4.1	12.2	-	10.2	-	8.3	112				
120	6.4	13.6	6.6	13.0	5.9	13.6	5.2	12.6	4.3	12.2	-	10.2	-	8.2	-	6.5	120				
128	5.2	11.6	5.5	11.8	4.7	12.0	4.0	11.1	3.0	10.7	-	8.7	-	6.7	-	5.0	128				
136	4.1	10.7	4.4	10.8	3.5	10.1	2.9	10.2	-	9.2	-	7.5	-	5.5	-	3.8	136				
144	-	-	3.4	9.3	2.7	8.7	-	8.7	-	7.8	-	6.4	-	4.5	-	2.7	144				
152	-	-	-	-	-	7.9	-	7.4	-	6.5	-	5.2	-	3.4	-	-	152				
160	-	-	-	-	-	7.2	-	6.4	-	5.4	-	4.3	-	-	-	-	160				
168	-	-	-	-	-	-	-	5.5	-	4.5	-	3.3	-	-	-	-	168				
176	-	-	-	-	-	-	-	4.5	-	3.6	-	2.3	-	-	-	-	176				
184	-	-	-	-	-	-	-	-	-	2.8	-	-	-	-	-	-	184				
1)	3.7	6.6	2.4	5.3	-	3.3	-	-	-	-	-	-	-	-	-	-	1)				

1) Capacities with horizontal boom
 * Max. values are valid only for specific superstructure positions

0 lb		23.00 ft x 29.10 ft																360° / Max.*				85%											
		360°		Max.		360°		Max.		360°		Max.		360°		Max.		360°		Max.													
		42.0ft		42.0ft		55.4ft		55.4ft		68.9ft		68.9ft		82.3ft		82.3ft		95.8ft		95.8ft		109.3ft		109.3ft		122.7ft		122.7ft		136.2ft		136.2ft	
ft		1,000 lb																												ft			
10		285.8	286.6	285.8	286.6	280.5	286.6	229.1	248.0	-	-	-	-	-	-	-	-	-	-	-	-	-	-	-	-	-	-	-	-	-	-	10	
12		270.8	282.0	256.3	282.0	205.7	281.6	173.7	248.0	-	-	-	-	-	-	-	-	-	-	-	-	-	-	-	-	-	-	-	-	-	-	12	
14		223.2	256.6	184.2	256.7	158.0	255.4	140.3	245.4	123.5	193.1	-	-	-	-	-	-	-	-	-	-	-	-	-	-	-	-	-	-	-	-	14	
16		162.3	222.2	142.0	223.9	125.7	223.7	112.6	222.2	104.6	189.6	-	-	-	-	-	-	-	-	-	-	-	-	-	-	-	-	-	-	-	-	16	
18		124.0	194.7	115.8	196.4	106.4	196.1	98.7	194.6	89.3	178.9	80.3	145.4	-	-	-	-	-	-	-	-	-	-	-	-	-	-	-	-	-	-	18	
20		91.8	170.0	94.8	171.6	90.1	171.3	83.8	173.0	75.9	163.6	69.5	139.4	65.2	119.8	-	-	-	-	-	-	-	-	-	-	-	-	-	-	-	-	20	
24		57.7	136.7	66.0	138.3	67.4	138.5	63.7	132.9	58.3	118.6	57.0	105.1	51.5	98.9	49.2	86.2	49.2	86.2	49.2	86.2	49.2	86.2	49.2	86.2	49.2	86.2	49.2	86.2	49.2	86.2	24	
28		39.7	113.2	46.7	115.6	49.6	110.3	49.7	99.1	49.6	92.2	45.9	87.0	43.2	76.8	41.2	69.5	41.2	69.5	41.2	69.5	41.2	69.5	41.2	69.5	41.2	69.5	41.2	69.5	41.2	69.5	28	
32		28.8	95.6	34.9	93.1	38.5	85.4	39.8	81.0	40.4	75.9	38.0	69.6	37.1	63.7	35.3	59.3	35.3	59.3	35.3	59.3	35.3	59.3	35.3	59.3	35.3	59.3	35.3	59.3	35.3	59.3	32	
36		-	-	27.7	74.2	31.0	70.5	32.7	66.6	33.0	64.3	32.7	57.6	31.7	53.0	30.2	49.9	30.2	49.9	30.2	49.9	30.2	49.9	30.2	49.9	30.2	49.9	30.2	49.9	30.2	49.9	36	
40		-	-	21.6	61.9	25.1	58.0	26.4	57.6	27.3	53.6	27.8	49.1	27.3	46.9	25.7	43.7	25.7	43.7	25.7	43.7	25.7	43.7	25.7	43.7	25.7	43.7	25.7	43.7	25.7	43.7	40	
48		-	-	-	-	17.5	42.6	18.6	42.5	19.9	39.6	19.9	38.2	20.1	37.6	19.3	34.2	19.3	34.2	19.3	34.2	19.3	34.2	19.3	34.2	19.3	34.2	19.3	34.2	19.3	34.2	48	
56		-	-	-	-	12.6	31.3	13.5	31.9	14.6	31.0	14.6	31.6	14.9	29.7	14.6	28.0	14.6	28.0	14.6	28.0	14.6	28.0	14.6	28.0	14.6	28.0	14.6	28.0	14.6	28.0	56	
64		-	-	-	-	-	-	10.1	24.7	11.0	26.2	11.0	25.5	11.2	23.6	11.0	23.9	11.0	23.9	11.0	23.9	11.0	23.9	11.0	23.9	11.0	23.9	11.0	23.9	11.0	23.9	64	
72		-	-	-	-	-	-	7.5	20.6	8.4	20.8	8.4	20.6	8.7	20.8	8.2	19.5	8.2	19.5	8.2	19.5	8.2	19.5	8.2	19.5	8.2	19.5	8.2	19.5	8.2	19.5	72	
80		-	-	-	-	-	-	-	6.4	16.9	6.4	17.2	6.6	17.3	6.3	16.7	6.3	16.7	6.3	16.7	6.3	16.7	6.3	16.7	6.3	16.7	6.3	16.7	6.3	16.7	6.3	16.7	80
88		-	-	-	-	-	-	-	4.7	12.5	4.7	12.5	4.7	12.5	4.5	14.2	4.5	14.2	4.5	14.2	4.5	14.2	4.5	14.2	4.5	14.2	4.5	14.2	4.5	14.2	4.5	14.2	88
96		-	-	-	-	-	-	-	-	-	-	3.3	12.3	3.5	12.0	3.1	12.0	3.1	12.0	3.1	12.0	3.1	12.0	3.1	12.0	3.1	12.0	3.1	12.0	3.1	12.0	96	
104		-	-	-	-	-	-	-	-	-	-	-	10.4	-	10.2	-	10.2	-	10.2	-	10.2	-	10.2	-	10.2	-	10.2	-	10.2	-	10.2	104	
112		-	-	-	-	-	-	-	-	-	-	-	-	-	8.9	-	8.5	-	8.5	-	8.5	-	8.5	-	8.5	-	8.5	-	8.5	-	8.5	112	
120		-	-	-	-	-	-	-	-	-	-	-	-	-	-	-	7.0	-	7.0	-	7.0	-	7.0	-	7.0	-	7.0	-	7.0	-	7.0	120	
128		-	-	-	-	-	-	-	-	-	-	-	-	-	-	-	5.7	-	5.7	-	5.7	-	5.7	-	5.7	-	5.7	-	5.7	-	5.7	128	
1)		26.5	45.9	15.4	33.7	10.1	26.5	6.8	19.8	4.6	14.3	2.4	11.0	-	8.4	-	5.5	-	5.5	-	5.5	-	5.5	-	5.5	-	5.5	-	5.5	-	5.5	1)	

		360°		Max.		360°		Max.		360°		Max.		360°		Max.		360°		Max.		360°		Max.		360°		Max.					
		149.6ft		149.6ft		162.4ft		162.4ft		175.9ft		175.9ft		190.0ft		190.0ft		203.4ft		203.4ft		216.9ft		216.9ft		230.3ft		230.3ft		255.9ft		255.9ft	
ft		1,000 lb																												ft			
28		39.4	61.9	-	-	-	-	-	-	-	-	-	-	-	-	-	-	-	-	-	-	-	-	-	-	-	-	-	-	-	-	28	
32		32.9	53.7	28.9	46.1	-	-	-	-	-	-	-	-	-	-	-	-	-	-	-	-	-	-	-	-	-	-	-	-	-	-	32	
36		28.2	47.5	27.4	43.3	-	-	-	-	-	-	-	-	-	-	-	-	-	-	-	-	-	-	-	-	-	-	-	-	-	-	36	
40		24.0	41.1	23.3	39.8	21.4	36.8	17.7	35.7	-	-	-	-	-	-	-	-	-	-	-	-	-	-	-	-	-	-	-	-	-	-	40	
48		17.9	33.1	17.7	31.1	16.0	30.6	13.9	28.8	12.0	26.9	-	-	-	-	-	-	-	-	-	-	-	-	-	-	-	-	-	-	-	-	48	
56		13.6	26.7	13.5	26.0	11.9	25.1	10.2	23.9	8.5	21.9	-	18.9	-	-	-	-	-	-	-	-	-	-	-	-	-	-	-	-	-	-	56	
64		10.1	22.9	10.3	22.0	8.9	20.9	7.3	19.4	5.6	17.6	-	15.3	-	12.7	-	-	-	-	-	-	-	-	-	-	-	-	-	-	-	-	64	
72		7.5	19.9	7.6	18.4	6.4	17.7	4.9	15.7	3.6	14.0	-	12.0	-	9.8	-	7.6	-	7.6	-	7.6	-	7.6	-	7.6	-	7.6	-	7.6	-	7.6	72	
80		5.5	16.4	5.7	16.2	4.6	15.1	-	12.9	-	11.0	-	9.1	-	6.9	-	4.7	-	4.7	-	4.7	-	4.7	-	4.7	-	4.7	-	4.7	-	4.7	80	
88		3.8	13.2	4.1	13.6	2.9	12.5	-	10.7	-	8.8	-	6.7	-	4.6	-	-	-	-	-	-	-	-	-	-	-	-	-	-	-	-	88	
96		-	10.9	-	11.1	-	10.1	-	8.6	-	7.1	-	5.1	-	3.1	-	-	-	-	-	-	-	-	-	-	-	-	-	-	-	-	96	
104		-	9.2	-	9.1	-	8.2	-	6.8	-	5.3	-	3.5	-	-	-	-	-	-	-	-	-	-	-	-	-	-	-	-	-	-	104	
112		-	7.6	-	7.7	-	6.5	-	5.2	-	3.9	-	-	-	-	-	-	-	-	-	-	-	-	-	-	-	-	-	-	-	-	112	
120		-	6.3	-	6.5	-	5.2	-	3.9	-	-	-	-	-	-	-	-	-	-	-	-	-	-	-	-	-	-	-	-	-	-	120	
128		-	5.0	-	5.3	-	4.2	-	2.9	-	-	-	-	-	-	-	-	-	-	-	-	-	-	-	-	-	-	-	-	-	-	128	
136		-	3.9	-	4.2	-	3.3	-	-	-	-	-	-	-	-	-	-	-	-	-	-	-	-	-	-	-	-	-	-	-	-	136	
144		-	-	-	3.1	-	2.5	-	-	-	-	-	-	-	-	-	-	-	-	-	-	-	-	-	-	-	-	-	-	-	-	144	
1)		-	3.5	-	2.2	-	-	-	-	-	-	-	-	-	-	-	-	-	-	-	-	-	-	-	-	-	-	-	-	-	-	1)	

1) Capacities with horizontal boom

* Max. values are valid only for specific superstructure positions

113,800 lb		18.20 ft x 29.10 ft		360° / Max.*												85%	
ft	360° 42.0ft	Max. 42.0ft	360° 55.4ft	Max. 55.4ft	360° 68.9ft	Max. 68.9ft	360° 82.3ft	Max. 82.3ft	360° 95.8ft	Max. 95.8ft	360° 109.3ft	Max. 109.3ft	360° 122.7ft	Max. 122.7ft	360° 136.2ft	Max. 136.2ft	ft
1,000 lb																	
10	-	286.6	-	286.6	-	286.6	-	248.0	-	-	-	-	-	-	-	-	10
12	-	285.2	-	284.9	-	285.6	-	248.0	-	-	-	-	-	-	-	-	12
14	-	272.8	-	270.6	-	272.7	-	248.0	-	193.1	-	-	-	-	-	-	14
16	-	251.3	-	249.9	-	250.2	-	245.5	-	189.6	-	-	-	-	-	-	16
18	-	232.7	-	232.4	-	232.0	-	231.8	-	188.1	-	154.1	-	-	-	-	18
20	184.4	215.2	186.0	215.9	185.8	214.9	180.8	215.8	170.3	187.2	151.1	153.0	122.6	122.6	-	-	20
24	145.5	185.3	147.7	185.5	147.4	186.4	147.5	185.1	137.7	177.8	129.2	149.7	116.7	119.6	97.2	97.2	24
28	111.1	157.8	113.4	159.2	115.4	158.9	114.9	157.6	112.2	156.1	111.1	146.4	101.5	116.5	93.4	93.4	28
32	88.8	108.6	91.8	136.8	92.5	136.4	93.0	135.1	94.0	136.8	92.4	134.1	92.0	112.8	85.2	90.7	32
36	-	-	77.1	119.8	77.7	119.5	79.9	118.6	79.1	119.8	78.3	118.0	79.6	108.2	74.7	87.3	36
40	-	-	65.7	102.9	67.0	104.5	67.0	106.0	68.2	104.7	68.3	103.0	66.7	102.7	65.9	83.6	40
48	-	-	-	-	50.9	84.5	52.3	85.2	52.8	83.9	52.0	84.3	50.7	83.9	50.4	75.5	48
56	-	-	-	-	41.5	64.4	42.1	70.3	41.8	70.0	41.2	70.7	40.6	69.0	39.6	67.8	56
64	-	-	-	-	-	-	34.4	59.3	34.0	60.7	33.4	59.6	33.1	57.8	33.5	59.2	64
72	-	-	-	-	-	-	28.8	45.6	28.3	52.2	27.7	51.1	28.8	51.9	27.7	50.7	72
80	-	-	-	-	-	-	-	24.1	44.4	25.1	44.3	24.5	45.6	23.5	44.0	80	
88	-	-	-	-	-	-	-	12.5	12.5	21.8	40.7	21.0	40.3	20.4	38.5	88	
96	-	-	-	-	-	-	-	-	-	18.9	33.8	18.2	35.7	17.7	33.9	96	
104	-	-	-	-	-	-	-	-	-	12.0	12.0	15.7	32.0	16.3	30.2	104	
112	-	-	-	-	-	-	-	-	-	-	-	9.0	9.0	14.4	26.7	112	
120	-	-	-	-	-	-	-	-	-	-	-	-	-	12.7	23.5	120	
128	-	-	-	-	-	-	-	-	-	-	-	-	-	-	8.6	8.6	128
1)	45.9	45.9	33.7	33.7	26.5	26.5	20.9	20.9	16.5	16.5	13.7	13.7	10.6	10.6	8.6	8.6	1)

ft	360° 149.6ft	Max. 149.6ft	360° 162.4ft	Max. 162.4ft	360° 175.9ft	Max. 175.9ft	360° 190.0ft	Max. 190.0ft	360° 203.4ft	Max. 203.4ft	360° 216.9ft	Max. 216.9ft	360° 230.3ft	Max. 230.3ft	360° 255.9ft	Max. 255.9ft	ft
1,000 lb																	
28	83.5	83.5	-	-	-	-	-	-	-	-	-	-	-	-	-	-	28
32	79.4	81.4	71.0	71.0	-	-	-	-	-	-	-	-	-	-	-	-	32
36	71.2	78.1	65.5	69.2	-	-	-	-	-	-	-	-	-	-	-	-	36
40	63.7	74.4	59.9	66.8	57.0	60.2	50.7	51.0	-	-	-	-	-	-	-	-	40
48	49.6	64.6	48.9	59.2	47.0	55.1	44.5	49.2	40.8	41.4	-	-	-	-	-	-	48
56	39.8	56.4	39.1	52.3	38.4	49.3	37.7	45.6	36.0	39.5	33.6	33.6	-	-	-	-	56
64	32.1	49.5	32.5	46.2	31.8	43.9	30.7	41.4	30.6	36.2	29.7	31.2	27.4	27.4	-	-	64
72	27.6	44.2	26.8	40.7	26.3	39.3	26.7	37.1	25.7	33.1	25.0	28.7	25.2	25.2	19.2	19.2	72
80	23.4	39.7	23.2	36.0	23.2	35.1	22.6	33.4	22.2	30.4	22.1	26.6	21.3	23.3	18.6	18.7	80
88	20.4	35.6	20.4	32.4	19.7	31.2	19.6	30.0	19.7	27.8	18.6	24.8	17.9	21.5	17.2	18.1	88
96	17.8	32.3	17.6	29.3	17.2	28.0	17.5	26.9	16.9	25.4	16.7	23.2	15.1	20.2	14.6	17.4	96
104	15.7	29.2	15.1	26.8	15.8	25.1	15.1	24.3	14.9	23.2	14.4	21.8	12.6	18.9	12.2	16.4	104
112	13.6	26.0	13.8	24.4	14.0	22.8	13.2	21.9	13.3	21.1	12.5	20.2	10.7	17.8	10.3	15.6	112
120	12.2	23.8	12.6	22.1	12.2	20.8	12.0	19.8	11.5	19.2	10.6	18.6	8.9	16.6	8.7	14.7	120
128	11.2	22.1	11.1	19.7	10.7	19.2	10.7	18.1	10.0	17.4	9.1	17.2	7.5	15.6	7.0	13.8	128
136	10.3	19.9	9.9	17.5	9.3	17.6	9.5	16.6	8.7	15.8	8.0	15.7	5.9	14.6	5.6	13.0	136
144	-	-	8.9	15.3	8.4	15.5	8.2	15.3	7.5	14.6	6.7	14.2	4.5	13.7	4.5	12.2	144
152	-	-	-	7.8	7.8	13.6	7.4	13.9	6.7	13.3	5.6	12.9	3.4	12.9	3.2	11.1	152
160	-	-	-	-	7.0	11.9	6.4	12.5	5.6	12.3	4.5	11.9	-	12.0	-	10.3	160
168	-	-	-	-	-	-	5.6	11.0	4.6	11.4	3.6	11.1	-	11.0	-	9.5	168
176	-	-	-	-	-	-	4.7	10.0	3.7	10.5	2.8	10.5	-	10.1	-	8.7	176
184	-	-	-	-	-	-	-	-	3.0	9.9	-	9.8	-	9.0	-	7.9	184
192	-	-	-	-	-	-	-	-	-	-	-	9.1	-	8.2	-	7.1	192
200	-	-	-	-	-	-	-	-	-	-	-	8.1	-	7.2	-	6.3	200
208	-	-	-	-	-	-	-	-	-	-	-	-	-	6.1	-	5.6	208
216	-	-	-	-	-	-	-	-	-	-	-	-	-	4.9	-	4.9	216
224	-	-	-	-	-	-	-	-	-	-	-	-	-	-	-	4.2	224
1)	6.6	6.6	5.3	5.3	3.3	-	-	-	-	-	-	-	-	-	-	-	1)

1) Capacities with horizontal boom

* Max. values are valid only for specific superstructure positions

41,200 lb		18.20 ft x 29.10 ft																360° / Max.*		85%												
360° 42.0ft		Max. 42.0ft		360° 55.4ft		Max. 55.4ft		360° 68.9ft		Max. 68.9ft		360° 82.3ft		Max. 82.3ft		360° 95.8ft		Max. 95.8ft		360° 109.3ft		Max. 109.3ft		360° 122.7ft		Max. 122.7ft		360° 136.2ft		Max. 136.2ft		
ft		1,000 lb																												ft		
10	284.1	286.6	284.2	286.6	281.2	286.6	234.8	248.0	-	-	-	-	-	-	-	-	-	-	-	-	-	-	-	-	-	-	-	-	-	-	-	10
12	253.2	285.2	248.4	284.9	217.2	285.6	191.6	248.0	-	-	-	-	-	-	-	-	-	-	-	-	-	-	-	-	-	-	-	-	-	-	-	12
14	221.3	271.7	200.2	270.0	178.3	271.5	156.1	248.0	143.7	193.1	-	-	-	-	-	-	-	-	-	-	-	-	-	-	-	-	-	-	-	-	-	14
16	177.2	243.5	162.6	243.6	147.0	242.3	135.8	239.9	122.1	189.6	-	-	-	-	-	-	-	-	-	-	-	-	-	-	-	-	-	-	-	-	-	16
18	139.9	217.5	137.4	217.7	125.8	218.9	118.1	217.5	109.4	188.1	101.6	154.1	-	-	-	-	-	-	-	-	-	-	-	-	-	-	-	-	-	-	-	18
20	107.8	193.5	114.5	195.2	111.0	195.0	102.0	193.5	97.8	185.1	89.4	153.0	82.3	122.6	-	-	-	-	-	-	-	-	-	-	-	-	-	-	-	-	-	20
24	75.1	156.0	81.0	157.5	82.7	157.3	83.6	156.8	78.5	157.7	72.2	146.2	68.2	119.6	64.0	97.2	-	-	-	-	-	-	-	-	-	-	-	-	-	-	-	24
28	55.7	129.7	61.8	131.0	64.4	130.6	65.2	132.4	64.0	131.1	60.9	123.1	57.6	112.9	54.4	93.4	-	-	-	-	-	-	-	-	-	-	-	-	-	-	-	28
32	43.2	101.8	48.6	111.4	50.9	112.6	51.8	112.5	51.5	111.4	51.1	106.9	49.9	96.0	46.3	90.7	-	-	-	-	-	-	-	-	-	-	-	-	-	-	-	32
36	-	-	40.1	97.3	42.3	99.0	43.1	98.4	42.8	94.2	44.3	90.6	42.7	84.5	40.2	79.3	-	-	-	-	-	-	-	-	-	-	-	-	-	-	-	36
40	-	-	32.7	85.3	35.6	85.7	35.6	85.3	37.3	83.5	37.1	77.0	36.0	75.9	36.3	69.6	-	-	-	-	-	-	-	-	-	-	-	-	-	-	-	40
48	-	-	-	-	26.2	64.6	27.4	65.6	27.9	63.3	27.4	62.9	28.3	57.8	27.4	54.1	-	-	-	-	-	-	-	-	-	-	-	-	-	-	-	48
56	-	-	-	-	20.0	49.5	21.5	49.7	21.5	50.9	22.1	49.0	21.9	46.1	21.9	43.1	-	-	-	-	-	-	-	-	-	-	-	-	-	-	-	56
64	-	-	-	-	-	-	-	16.9	40.0	17.3	40.4	17.8	39.2	17.6	36.7	17.7	35.5	-	-	-	-	-	-	-	-	-	-	-	-	-	-	64
72	-	-	-	-	-	-	-	13.5	32.8	14.4	32.4	14.4	31.3	14.6	30.6	14.2	30.3	-	-	-	-	-	-	-	-	-	-	-	-	-	-	72
80	-	-	-	-	-	-	-	-	11.8	26.8	11.8	26.0	12.0	27.2	11.7	25.7	-	-	-	-	-	-	-	-	-	-	-	-	-	-	-	80
88	-	-	-	-	-	-	-	-	9.7	12.5	9.7	23.2	9.9	23.0	9.6	21.1	-	-	-	-	-	-	-	-	-	-	-	-	-	-	-	88
96	-	-	-	-	-	-	-	-	-	-	8.1	20.5	8.2	19.5	8.0	18.6	-	-	-	-	-	-	-	-	-	-	-	-	-	-	-	96
104	-	-	-	-	-	-	-	-	-	-	6.8	12.0	6.8	16.8	6.6	16.4	-	-	-	-	-	-	-	-	-	-	-	-	-	-	-	104
112	-	-	-	-	-	-	-	-	-	-	-	-	5.7	9.0	5.2	15.1	-	-	-	-	-	-	-	-	-	-	-	-	-	-	-	112
120	-	-	-	-	-	-	-	-	-	-	-	-	-	4.2	13.0	-	-	-	-	-	-	-	-	-	-	-	-	-	-	-	-	120
128	-	-	-	-	-	-	-	-	-	-	-	-	-	3.2	8.6	-	-	-	-	-	-	-	-	-	-	-	-	-	-	-	-	128
1)	40.3	45.9	24.9	33.7	17.6	26.5	12.8	20.9	9.7	16.5	7.1	13.7	5.3	10.6	2.9	8.6	-	-	-	-	-	-	-	-	-	-	-	-	-	-	-	1)

360° 149.6ft		Max. 149.6ft		360° 162.4ft		Max. 162.4ft		360° 175.9ft		Max. 175.9ft		360° 190.0ft		Max. 190.0ft		360° 203.4ft		Max. 203.4ft		360° 216.9ft		Max. 216.9ft		360° 230.3ft		Max. 230.3ft		360° 255.9ft		Max. 255.9ft		
ft		1,000 lb																												ft		
28	49.5	83.5	-	-	-	-	-	-	-	-	-	-	-	-	-	-	-	-	-	-	-	-	-	-	-	-	-	-	-	-	-	28
32	44.8	81.4	40.8	71.0	-	-	-	-	-	-	-	-	-	-	-	-	-	-	-	-	-	-	-	-	-	-	-	-	-	-	-	32
36	39.5	72.4	36.9	65.4	-	-	-	-	-	-	-	-	-	-	-	-	-	-	-	-	-	-	-	-	-	-	-	-	-	-	-	36
40	34.2	63.9	34.0	59.8	32.1	56.4	29.5	50.5	-	-	-	-	-	-	-	-	-	-	-	-	-	-	-	-	-	-	-	-	-	-	-	40
48	28.1	50.9	27.0	48.7	26.5	44.9	24.2	43.4	22.3	39.9	-	-	-	-	-	-	-	-	-	-	-	-	-	-	-	-	-	-	-	-	-	48
56	21.7	41.6	21.8	39.4	21.2	38.1	19.3	34.5	17.5	33.3	15.3	31.9	-	-	-	-	-	-	-	-	-	-	-	-	-	-	-	-	-	-	-	56
64	17.1	34.3	17.3	33.2	16.7	31.2	15.5	29.5	13.9	28.1	11.9	26.9	8.8	26.1	-	-	-	-	-	-	-	-	-	-	-	-	-	-	-	-	-	64
72	13.7	28.3	14.0	28.1	13.3	26.3	12.4	25.7	10.9	24.1	9.1	23.5	6.2	21.7	-	19.2	-	-	-	-	-	-	-	-	-	-	-	-	-	-	-	72
80	11.1	24.8	11.3	23.3	10.9	23.7	10.0	21.9	8.5	21.8	6.8	19.6	3.9	18.6	-	16.6	-	-	-	-	-	-	-	-	-	-	-	-	-	-	-	80
88	9.1	21.1	9.3	21.0	8.7	19.9	8.0	19.6	6.6	18.9	4.9	17.6	-	15.3	-	13.3	-	-	-	-	-	-	-	-	-	-	-	-	-	-	-	88
96	7.3	18.4	7.5	18.2	7.1	17.2	6.2	17.2	4.9	16.3	3.3	15.1	-	12.8	-	10.6	-	-	-	-	-	-	-	-	-	-	-	-	-	-	-	96
104	5.9	16.1	6.1	15.1	5.7	15.8	4.8	14.8	3.5	14.4	-	12.5	-	10.4	-	8.5	-	-	-	-	-	-	-	-	-	-	-	-	-	-	-	104
112	4.6	14.0	5.0	13.8	4.1	13.8	3.5	13.2	-	12.3	-	10.3	-	8.3	-	6.5	-	-	-	-	-	-	-	-	-	-	-	-	-	-	-	112
120	3.5	12.2	3.7	12.6	3.1	11.6	-	11.7	-	10.6	-	8.7	-	6.5	-	4.8	-	-	-	-	-	-	-	-	-	-	-	-	-	-	-	120
128	-	11.1	2.6	11.0	-	10.2	-	9.8	-	8.8	-	7.3	-	5.3	-	3.5	-	-	-	-	-	-	-	-	-	-	-	-	-	-	-	128
136	-	10.1	-	9.4	-	9.2	-	8.4	-	7.2	-	5.8	-	4.0	-	2.4	-	-	-	-	-	-	-	-	-	-	-	-	-	-	-	136
144	-	-	-	8.0	-	8.2	-	7.3	-	5.8	-	4.7	-	2.9	-	-	-	-	-	-	-	-	-	-	-	-	-	-	-	-	-	144
152	-	-	-	-	-	6.9	-	6.2	-	5.0	-	3.6	-	-	-	-	-	-	-	-	-	-	-	-	-	-	-	-	-	-	-	152
160	-	-	-	-	-	5.9	-	5.2	-	4.2	-	2.6	-	-	-	-	-	-	-	-	-	-	-	-	-	-	-	-	-	-	-	160
168	-	-	-	-	-	-	-	4.2	-	3.3	-	-	-	-	-	-	-	-	-	-	-	-	-	-	-	-	-	-	-	-	-	168
176	-	-	-	-	-	-	-	3.4	-	2.5	-	-	-	-	-	-	-	-	-	-	-	-	-	-	-	-	-	-	-	-	-	176
1)	-	6.6	-	5.3	-	3.3	-	-	-	-	-	-	-	-	-	-	-	-	-	-	-	-	-	-	-	-	-	-	-	-	-	1)

1) Capacities with horizontal boom

* Max. values are valid only for specific superstructure positions

0 lb		18.20 ft x 29.10 ft																360° / Max.*				85%											
		360°		Max.		360°		Max.		360°		Max.		360°		Max.		360°		Max.													
		42.0ft		42.0ft		55.4ft		55.4ft		68.9ft		68.9ft		82.3ft		82.3ft		95.8ft		95.8ft		109.3ft		109.3ft		122.7ft		122.7ft		136.2ft		136.2ft	
ft		1,000 lb																												ft			
10		251.4	286.6	198.3	286.6	162.2	286.6	138.0	248.0	-	-	-	-	-	-	-	-	-	-	-	-	-	-	-	-	-	-	-	-	-	-	10	
12		165.8	282.0	144.6	282.0	124.8	281.6	113.0	248.0	-	-	-	-	-	-	-	-	-	-	-	-	-	-	-	-	-	-	-	-	-	-	12	
14		120.0	256.6	110.1	256.7	102.2	255.4	91.4	245.4	80.8	193.1	-	-	-	-	-	-	-	-	-	-	-	-	-	-	-	-	-	-	-	14		
16		91.6	222.2	89.8	223.9	83.4	223.7	76.0	222.2	70.8	189.6	-	-	-	-	-	-	-	-	-	-	-	-	-	-	-	-	-	-	-	16		
18		71.2	194.7	74.8	196.4	70.7	196.1	65.2	190.5	62.6	167.1	56.7	140.5	-	-	-	-	-	-	-	-	-	-	-	-	-	-	-	-	-	18		
20		53.3	170.0	61.6	171.6	61.4	170.5	57.8	170.2	54.1	139.9	50.6	129.0	48.1	112.3	-	-	-	-	-	-	-	-	-	-	-	-	-	-	-	20		
24		34.9	136.7	41.9	136.4	46.0	131.1	45.4	113.3	42.5	105.7	41.0	98.8	38.6	87.7	35.5	78.7	24															
28		24.2	108.5	30.3	105.7	34.0	94.9	35.6	88.8	35.3	84.6	33.3	76.2	31.6	69.8	29.1	64.1	28															
32		17.3	81.1	22.7	82.6	26.5	75.7	27.9	72.9	28.9	67.3	27.5	61.5	26.2	57.2	24.2	52.9	32															
36		-	-	17.8	64.8	21.4	61.1	22.6	61.5	23.9	56.2	23.2	50.7	22.2	48.4	20.6	45.9	36															
40		-	-	13.7	52.6	17.0	52.7	18.1	50.0	19.3	46.6	19.4	44.5	18.8	42.6	17.2	39.8	40															
48		-	-	-	-	11.5	37.1	12.6	36.1	13.4	34.8	13.7	35.9	13.7	33.4	12.5	31.7	48															
56		-	-	-	-	7.7	27.7	8.7	27.6	9.6	28.9	9.8	27.9	10.0	26.1	9.1	26.3	56															
64		-	-	-	-	-	-	6.0	22.8	6.9	22.7	7.1	22.3	7.3	22.4	6.4	21.0	64															
72		-	-	-	-	-	-	3.8	18.4	4.9	18.4	4.9	18.8	5.1	18.4	4.5	17.7	72															
80		-	-	-	-	-	-	-	-	-	15.2	-	15.4	3.3	15.2	-	14.9	80															
88		-	-	-	-	-	-	-	-	-	12.4	-	13.1	-	12.5	-	12.5	88															
96		-	-	-	-	-	-	-	-	-	-	-	10.8	-	10.6	-	10.1	96															
104		-	-	-	-	-	-	-	-	-	-	-	9.0	-	9.0	-	8.2	104															
112		-	-	-	-	-	-	-	-	-	-	-	-	-	7.6	-	6.8	112															
120		-	-	-	-	-	-	-	-	-	-	-	-	-	-	-	5.7	120															
128		-	-	-	-	-	-	-	-	-	-	-	-	-	-	-	4.6	128															
1)		15.7	45.9	9.3	33.7	6.0	24.7	3.1	17.4	-	13.0	-	9.5	-	7.1	-	4.4	1)															

		360°		Max.		360°		Max.		360°		Max.		360°		Max.		360°		Max.		360°		Max.		360°		Max.					
		149.6ft		149.6ft		162.4ft		162.4ft		175.9ft		175.9ft		190.0ft		190.0ft		203.4ft		203.4ft		216.9ft		216.9ft		230.3ft		230.3ft		255.9ft		255.9ft	
ft		1,000 lb																												ft			
28		27.1	56.6	-	-	-	-	-	-	-	-	-	-	-	-	-	-	-	28														
32		22.5	50.0	18.9	44.6	-	-	-	-	-	-	-	-	-	-	-	-	-	32														
36		19.0	42.7	18.5	41.2	-	-	-	-	-	-	-	-	-	-	-	-	-	36														
40		15.9	38.5	15.5	35.9	13.8	35.3	-	33.1	-	-	-	-	-	-	-	-	-	40														
48		11.4	30.1	11.2	29.5	9.7	28.1	-	26.8	-	24.7	-	-	-	-	-	-	-	48														
56		8.0	25.6	8.0	24.1	6.8	23.2	-	21.5	-	19.3	-	17.1	-	-	-	-	-	56														
64		5.3	21.3	5.5	20.3	4.2	18.9	-	17.3	-	15.5	-	13.1	-	10.8	-	-	-	64														
72		3.3	17.3	3.6	17.3	2.5	15.9	-	13.7	-	12.2	-	10.0	-	7.8	-	-	-	72														
80		-	13.9	-	14.3	-	13.0	-	11.3	-	9.3	-	7.3	-	5.1	-	-	-	80														
88		-	11.4	-	11.5	-	10.4	-	9.0	-	7.4	-	5.2	-	3.1	-	-	-	88														
96		-	9.2	-	9.5	-	8.3	-	7.0	-	5.4	-	3.6	-	-	-	-	-	96														
104		-	7.5	-	7.7	-	6.6	-	5.1	-	3.7	-	-	-	-	-	-	-	104														
112		-	5.9	-	6.1	-	5.4	-	3.7	-	-	-	-	-	-	-	-	-	112														
120		-	4.7	-	4.8	-	4.1	-	2.8	-	-	-	-	-	-	-	-	-	120														
128		-	3.7	-	3.7	-	2.9	-	-	-	-	-	-	-	-	-	-	-	128														
136		-	2.8	-	2.8	-	-	-	-	-	-	-	-	-	-	-	-	-	136														
144		-	-	-	2.2	-	-	-	-	-	-	-	-	-	-	-	-	-	144														
1)		-	2.4	-	-	-	-	-	-	-	-	-	-	-	-	-	-	-	1)														

1) Capacities with horizontal boom

* Max. values are valid only for specific superstructure positions

0 lb		9.00 ft x 29.10 ft																360° / Max.*				85%	
ft		360°	Max.	360°	Max.	360°	Max.	360°	Max.	360°	Max.	360°	Max.	360°	Max.	360°	Max.	ft					
ft		42.0ft	42.0ft	55.4ft	55.4ft	68.9ft	68.9ft	82.3ft	82.3ft	95.8ft	95.8ft	109.3ft	109.3ft	122.7ft	122.7ft	136.2ft	136.2ft	ft					
ft		1,000 lb																ft					
10	53.8	286.6	54.2	286.6	52.1	157.1	48.5	102.0	-	-	-	-	-	-	-	-	-	-	10				
12	40.2	282.0	42.8	282.0	42.4	157.2	40.3	103.4	-	-	-	-	-	-	-	-	-	-	12				
14	29.9	256.6	34.5	256.7	35.1	161.9	33.8	105.1	32.2	75.2	-	-	-	-	-	-	-	-	14				
16	21.9	222.2	28.1	223.9	29.5	167.3	28.5	107.0	27.5	74.1	-	-	-	-	-	-	-	-	16				
18	16.9	194.7	22.8	196.4	25.2	167.3	24.7	105.0	23.9	75.2	22.2	58.4	-	-	-	-	-	-	18				
20	12.5	170.0	18.0	170.3	21.3	166.3	21.2	107.3	20.5	76.2	19.2	59.0	17.7	47.9	-	-	-	-	20				
24	6.0	132.0	12.0	123.6	15.3	112.3	15.9	103.9	15.8	78.7	14.8	59.1	13.7	47.0	12.2	38.9	-	-	24				
28	-	89.0	7.6	88.4	11.0	84.3	12.0	79.1	12.3	74.2	11.5	59.5	10.7	46.5	9.2	39.6	-	-	28				
32	-	60.6	4.2	66.5	8.0	65.7	9.0	64.5	9.4	60.0	8.9	55.4	8.2	47.6	6.8	38.9	-	-	32				
36	-	-	-	52.2	5.6	54.0	6.7	52.7	7.2	49.3	6.8	46.6	6.3	43.9	5.0	37.9	-	-	36				
40	-	-	-	40.0	-	42.4	-	42.9	5.3	41.1	4.9	41.9	4.6	38.9	-	36.5	-	-	40				
48	-	-	-	-	-	31.0	-	30.4	-	32.1	-	31.4	-	29.8	-	29.7	-	-	48				
56	-	-	-	-	-	23.2	-	24.2	-	24.5	-	23.8	-	24.5	-	23.7	-	-	56				
64	-	-	-	-	-	-	-	19.3	-	19.1	-	19.7	-	19.3	-	19.3	-	-	64				
72	-	-	-	-	-	-	-	15.1	-	15.7	-	15.9	-	15.7	-	15.7	-	-	72				
80	-	-	-	-	-	-	-	-	-	13.0	-	12.8	-	13.0	-	12.6	-	-	80				
88	-	-	-	-	-	-	-	-	-	10.5	-	10.5	-	10.5	-	10.1	-	-	88				
96	-	-	-	-	-	-	-	-	-	-	-	8.5	-	8.5	-	8.1	-	-	96				
104	-	-	-	-	-	-	-	-	-	-	-	6.8	-	6.8	-	6.4	-	-	104				
112	-	-	-	-	-	-	-	-	-	-	-	-	-	5.4	-	5.0	-	-	112				
120	-	-	-	-	-	-	-	-	-	-	-	-	-	-	-	3.7	-	-	120				
128	-	-	-	-	-	-	-	-	-	-	-	-	-	-	-	2.8	-	-	128				
1)	-	45.9	-	30.2	-	20.7	-	14.6	-	10.8	-	7.3	-	4.9	-	2.6	-	-	1)				

ft		360°	Max.	360°	Max.	360°	Max.	360°	Max.	360°	Max.	360°	Max.	360°	Max.	360°	Max.	ft	
ft		149.6ft	149.6ft	162.4ft	162.4ft	175.9ft	175.9ft	190.0ft	190.0ft	203.4ft	203.4ft	216.9ft	216.9ft	230.3ft	230.3ft	255.9ft	255.9ft	ft	
ft		1,000 lb																ft	
28	-	32.1	-	-	-	-	-	-	-	-	-	-	-	-	-	-	-	-	28
32	-	32.5	-	25.1	-	-	-	-	-	-	-	-	-	-	-	-	-	-	32
36	-	33.2	-	28.2	-	-	-	-	-	-	-	-	-	-	-	-	-	-	36
40	-	33.4	-	28.5	-	23.2	-	17.0	-	-	-	-	-	-	-	-	-	-	40
48	-	28.7	-	26.7	-	23.7	-	18.0	-	14.0	-	-	-	-	-	-	-	-	48
56	-	23.2	-	22.5	-	21.6	-	18.1	-	14.3	-	9.8	-	-	-	-	-	-	56
64	-	18.7	-	18.5	-	17.1	-	15.5	-	13.4	-	10.3	-	6.7	-	-	-	-	64
72	-	14.8	-	15.1	-	13.7	-	12.2	-	10.4	-	8.4	-	6.2	-	-	-	-	72
80	-	11.7	-	11.9	-	10.9	-	9.3	-	7.8	-	5.8	-	3.7	-	-	-	-	80
88	-	9.1	-	9.4	-	8.5	-	7.0	-	5.5	-	3.8	-	-	-	-	-	-	88
96	-	7.2	-	7.4	-	6.7	-	5.2	-	3.8	-	-	-	-	-	-	-	-	96
104	-	5.5	-	5.9	-	5.0	-	3.7	-	2.4	-	-	-	-	-	-	-	-	104
112	-	4.1	-	4.3	-	3.7	-	-	-	-	-	-	-	-	-	-	-	-	112
120	-	3.1	-	3.3	-	-	-	-	-	-	-	-	-	-	-	-	-	-	120
1)	-	-	-	-	-	-	-	-	-	-	-	-	-	-	-	-	-	-	1)

1) Capacities with horizontal boom

* Max. values are valid only for specific superstructure positions

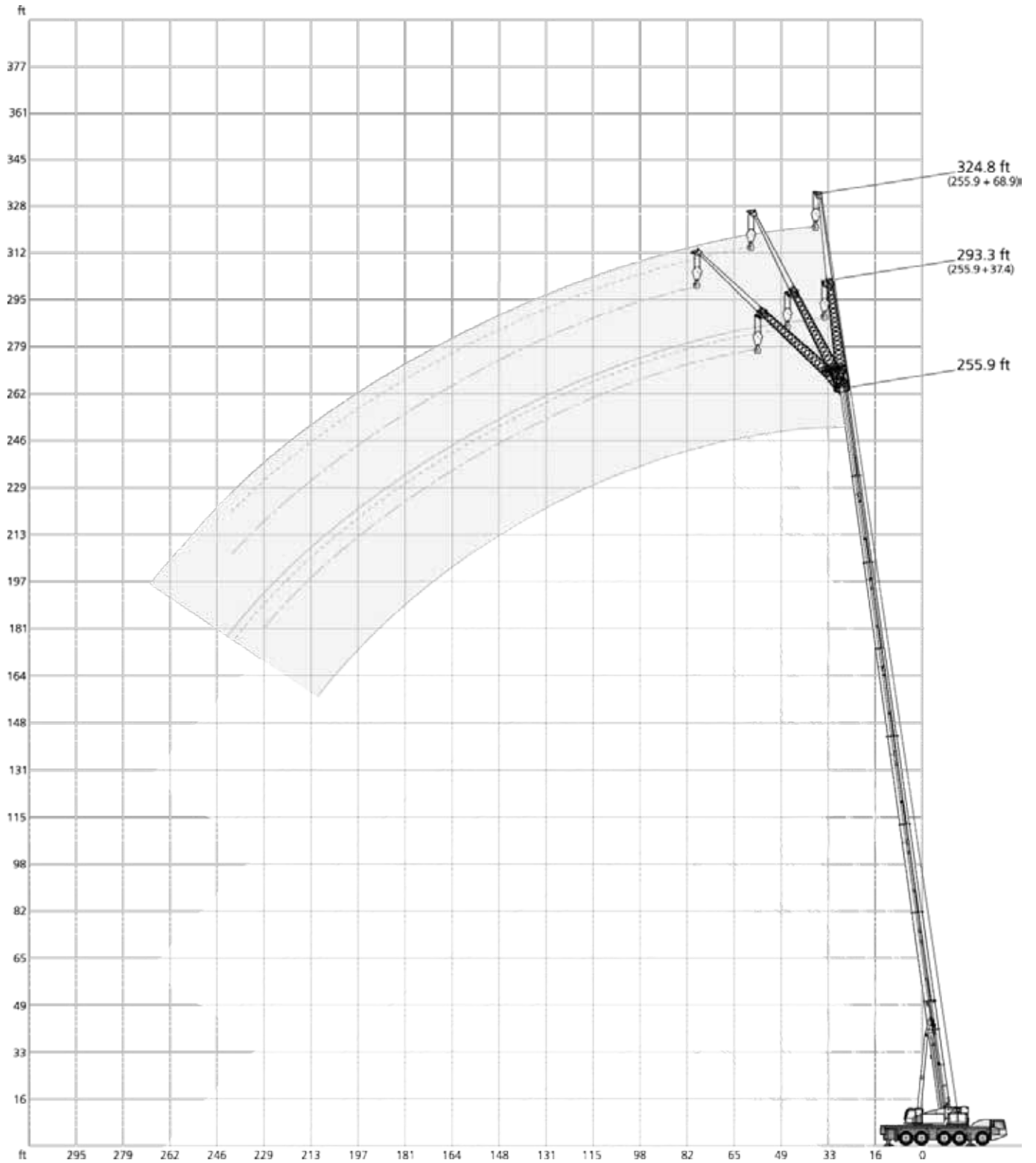
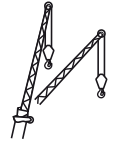

154,800 lb		27.60 ft x 29.10 ft		360°		85%									
42.0 ft								136.2 ft							
ft	37.4 ft			68.9 ft			ft	37.4 ft			68.9 ft				
	0°	20°	40°	0°	20°	40°		0°	20°	40°	0°	20°	40°		
1,000 lb															
10	41.2	-	-	-	-	-	32	41.2	-	-	-	-	-		
12	41.2	-	-	22.9	-	-	36	41.2	-	-	17.6	-	-		
14	41.2	-	-	22.8	-	-	40	41.0	-	-	17.4	-	-		
16	41.2	-	-	22.4	-	-	48	38.0	27.9	-	16.8	-	-		
18	41.2	-	-	22.1	-	-	56	34.3	26.0	21.0	16.3	-	-		
20	41.2	34.8	-	21.8	-	-	64	31.4	24.2	20.4	15.8	12.3	-		
24	41.2	32.0	-	21.2	-	-	72	28.7	22.7	19.6	15.2	11.7	-		
28	39.7	29.7	-	20.3	-	-	80	26.3	21.6	19.1	14.7	11.2	9.0		
32	36.0	27.7	22.5	19.3	-	-	88	24.4	20.5	18.2	14.1	10.6	8.7		
36	33.0	26.1	21.5	18.2	-	-	96	22.9	19.5	17.6	13.5	10.2	8.6		
40	30.3	24.5	20.6	17.0	13.6	-	104	21.6	18.6	17.0	12.7	9.8	8.4		
48	26.1	21.9	19.3	14.9	12.3	-	112	20.2	17.8	16.7	11.9	9.5	8.2		
56	22.7	20.0	-	13.2	11.2	-	120	19.1	17.1	16.4	11.3	9.2	8.2		
64	20.1	18.7	-	11.7	10.3	9.1	128	18.2	16.5	6.2	10.8	8.9	8.0		
72	-	-	-	10.6	9.5	8.6	136	17.4	16.0	-	10.3	8.7	7.9		
80	-	-	-	9.8	9.0	8.3	144	16.6	15.7	-	9.7	8.4	7.9		
88	-	-	-	9.1	8.5	-	152	16.2	4.6	-	9.4	8.3	3.9		
96	-	-	-	8.5	-	-	160	13.6	-	-	9.0	8.2	-		
							168	-	-	-	8.8	8.1	-		
							176	-	-	-	8.6	8.0	-		
							184	-	-	-	8.5	2.4	-		

175.9 ft							
ft	37.4 ft			68.9 ft			
	0°	20°	40°	0°	20°	40°	
1,000 lb							
48	33.0	-	-	15.1	-	-	
56	32.6	-	-	14.8	-	-	
64	32.1	25.2	-	14.4	-	-	
72	30.9	23.8	19.9	14.1	-	-	
80	28.8	22.7	19.3	13.6	11.4	-	
88	27.0	21.6	18.8	13.4	11.1	-	
96	25.1	20.6	18.2	13.1	10.5	8.7	
104	23.0	19.7	17.9	12.6	10.2	8.4	
112	21.1	19.1	17.4	12.3	9.9	8.4	
120	19.2	18.3	16.9	12.1	9.6	8.2	
128	17.4	17.1	16.5	11.7	9.4	8.0	
136	15.8	15.9	16.0	11.1	9.1	7.9	
144	14.2	14.6	14.8	10.8	8.8	7.9	
152	12.9	13.3	13.5	10.3	8.6	7.9	
160	11.8	12.1	-	10.0	8.4	7.7	
168	10.8	11.0	-	9.5	8.3	7.7	
176	10.0	10.1	-	9.1	8.2	7.7	
184	9.2	9.3	-	8.5	7.9	7.7	
192	8.0	-	-	7.8	7.7	-	
200	5.3	-	-	7.3	7.4	-	
208	-	-	-	6.7	7.0	-	
216	-	-	-	6.2	6.4	-	
224	-	-	-	5.5	-	-	

255.9 ft							
ft	37.4 ft			68.9 ft			
	0°	20°	40°	0°	20°*	40°*	
1,000 lb							
80	11.2	-	-	7.0	-	-	
88	10.9	-	-	6.8	-	-	
96	10.7	10.7	-	6.7	-	-	
104	10.4	10.4	10.4	6.4	-	-	
112	9.9	10.1	9.9	6.4	6.6	-	
120	9.6	9.6	9.3	6.2	6.3	-	
128	9.4	9.0	8.7	6.1	6.1	5.8	
136	8.9	8.3	8.3	5.8	6.0	5.6	
144	8.4	7.9	7.7	5.7	5.7	5.3	
152	7.9	7.4	7.2	5.5	5.4	5.3	
160	7.3	7.0	6.9	5.2	5.0	5.0	
168	6.8	6.6	6.5	4.9	4.7	4.7	
176	6.3	6.2	6.2	4.7	4.4	4.4	
184	5.8	5.8	5.9	4.4	4.2	4.2	
192	5.4	5.5	5.6	4.1	3.9	3.9	
200	5.0	5.2	5.2	3.9	3.6	3.6	
208	4.6	4.8	4.8	3.6	3.4	3.4	
216	4.2	4.2	4.2	3.3	3.1	3.1	
224	3.7	3.8	3.8	3.1	3.0	3.0	
232	3.1	3.4	-	2.8	2.7	2.8	
240	2.6	2.8	-	2.5	2.3	2.5	

 *252.0 ft

113,800 lb		27.60 ft x 29.10 ft		360°		85%									
42.0 ft								136.2 ft							
ft	37.4 ft			68.9 ft			ft	37.4 ft			68.9 ft				
	0°	20°	40°	0°	20°	40°		0°	20°	40°	0°	20°	40°		
1,000 lb															
10	41.2	-	-	-	-	-	32	41.2	-	-	-	-	-		
12	41.2	-	-	22.9	-	-	36	41.2	-	-	17.6	-	-		
14	41.2	-	-	22.8	-	-	40	41.0	-	-	17.4	-	-		
16	41.2	-	-	22.4	-	-	48	38.0	27.9	-	16.8	-	-		
18	41.2	-	-	22.1	-	-	56	34.3	26.0	21.0	16.3	-	-		
20	41.2	34.8	-	21.8	-	-	64	31.4	24.2	20.4	15.8	12.3	-		
24	41.2	32.0	-	21.2	-	-	72	28.7	22.7	19.6	15.2	11.7	-		
28	39.7	29.7	-	20.3	-	-	80	26.3	21.6	19.1	14.7	11.2	9.0		
32	36.0	27.7	22.5	19.3	-	-	88	24.4	20.5	18.2	14.1	10.6	8.7		
36	33.0	26.1	21.5	18.2	-	-	96	22.9	19.5	17.6	13.5	10.2	8.6		
40	30.3	24.5	20.6	17.0	13.6	-	104	21.6	18.6	17.0	12.7	9.8	8.4		
48	26.1	21.9	19.3	14.9	12.3	-	112	20.2	17.8	16.7	11.9	9.5	8.2		
56	22.7	20.0	-	13.2	11.2	-	120	19.1	17.1	16.4	11.3	9.2	8.2		
64	20.1	18.7	-	11.7	10.3	9.1	128	17.9	16.5	6.2	10.8	8.9	8.0		
72	-	-	-	10.6	9.5	8.6	136	16.6	16.0	-	10.3	8.7	7.9		
80	-	-	-	9.8	9.0	8.3	144	14.6	15.2	-	9.7	8.4	7.9		
88	-	-	-	9.1	8.5	-	152	13.1	4.6	-	9.4	8.3	3.9		
96	-	-	-	8.5	-	-	160	10.6	-	-	9.0	8.2	-		
							168	-	-	-	8.8	8.1	-		
							176	-	-	-	8.6	8.0	-		
							184	-	-	-	8.5	2.4	-		

175.9 ft							
ft	37.4 ft			68.9 ft			
	0°	20°	40°	0°	20°	40°	
1,000 lb							
48	33.0	-	-	15.1	-	-	
56	32.6	-	-	14.8	-	-	
64	32.1	25.2	-	14.4	-	-	
72	30.9	23.8	19.9	14.1	-	-	
80	28.8	22.7	19.3	13.6	11.4	-	
88	27.0	21.6	18.8	13.4	11.1	-	
96	25.1	20.6	18.2	13.1	10.5	8.7	
104	23.0	19.7	17.9	12.6	10.2	8.4	
112	21.0	19.1	17.4	12.3	9.9	8.4	
120	17.9	18.3	16.9	12.1	9.6	8.2	
128	16.0	16.7	16.5	11.7	9.4	8.0	
136	14.2	15.0	15.2	11.1	9.1	7.9	
144	12.2	13.3	13.7	10.8	8.8	7.9	
152	10.7	11.4	11.9	10.3	8.6	7.9	
160	9.9	9.9	-	9.5	8.4	7.7	
168	8.9	9.1	-	8.2	8.3	7.7	
176	7.9	8.5	-	7.1	8.2	7.7	
184	6.9	7.3	-	6.7	7.1	7.3	
192	5.5	-	-	6.2	6.1	-	
200	5.3	-	-	5.4	5.8	-	
208	-	-	-	4.6	5.3	-	
216	-	-	-	4.2	4.5	-	
224	-	-	-	3.9	-	-	

255.9 ft							
ft	37.4 ft			68.9 ft			
	0°	20°	40°	0°	20°*	40°*	
1,000 lb							
80	11.2	-	-	7.0	-	-	
88	10.9	-	-	6.8	-	-	
96	10.7	10.7	-	6.7	-	-	
104	10.4	10.4	10.4	6.4	-	-	
112	9.9	10.1	9.9	6.4	6.6	-	
120	9.6	9.6	9.3	6.2	6.3	-	
128	9.4	9.0	8.7	6.1	6.1	5.8	
136	8.9	8.3	8.3	5.8	6.0	5.6	
144	8.4	7.9	7.7	5.7	5.7	5.3	
152	7.9	7.4	7.2	5.5	5.4	5.3	
160	7.3	7.0	6.9	5.2	5.0	5.0	
168	6.7	6.6	6.5	4.9	4.7	4.7	
176	5.8	6.2	6.2	4.7	4.4	4.4	
184	4.8	5.5	5.7	4.2	4.2	4.2	
192	3.8	4.6	5.1	3.6	3.9	3.9	
200	2.8	3.5	4.0	2.8	3.6	3.6	
208	-	-	-	-	3.2	3.4	
216	-	-	-	-	2.7	3.1	

 *252.0 ft

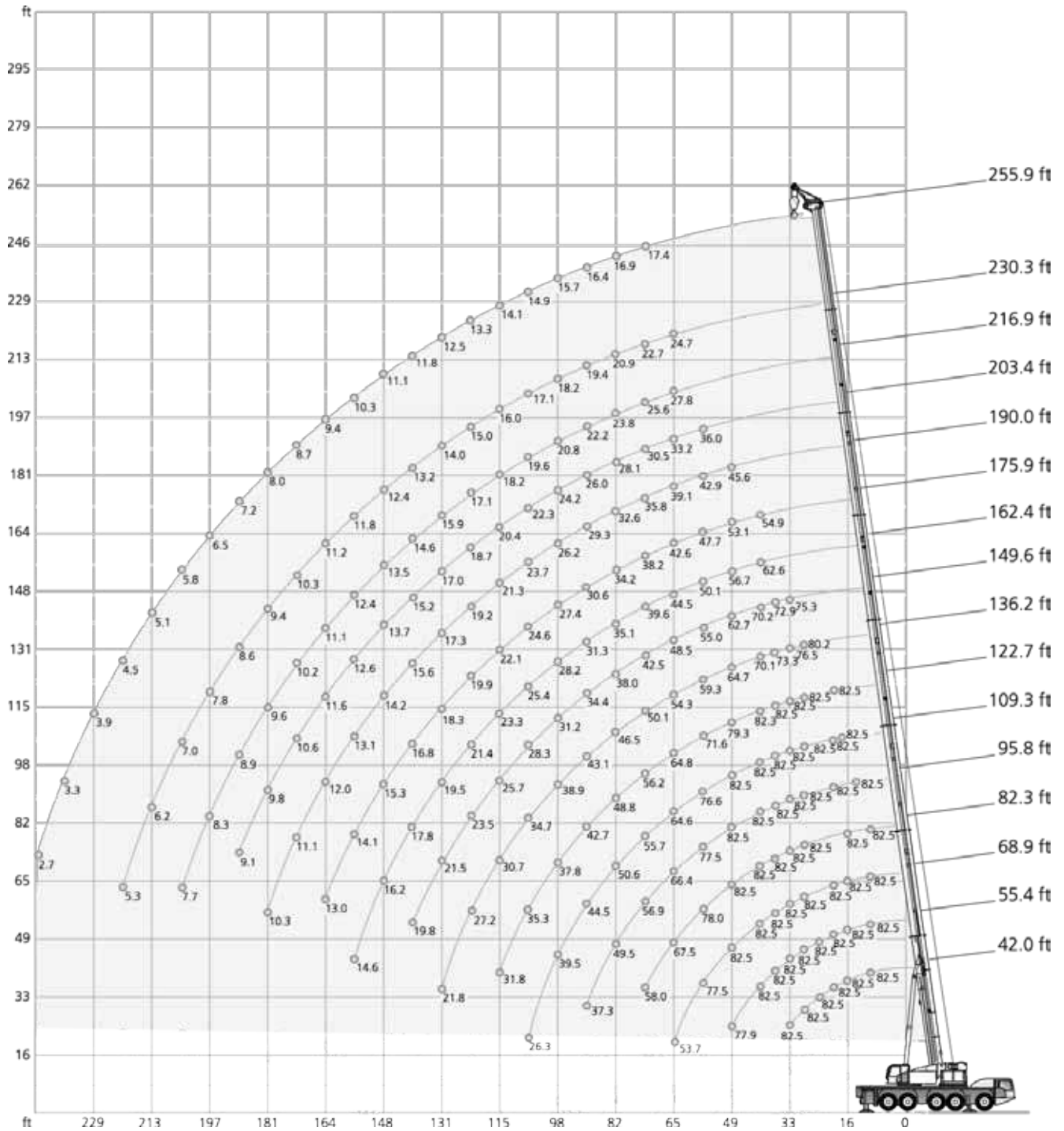

154,800 lb		27.60 ft x 29.10 ft																360°		85%	
		(ft)																			
		42.0	55.4	68.9	82.3	95.8	109.3	122.7	136.2	149.6	162.4	175.9	190.0	203.4	216.9	230.3	255.9				
ft		1,000 lb																ft			
10		82.5	82.5	82.5	-	-	-	-	-	-	-	-	-	-	-	-	-	-	10		
12		82.5	82.5	82.5	82.5	-	-	-	-	-	-	-	-	-	-	-	-	-	12		
14		82.5	82.5	82.5	82.5	-	-	-	-	-	-	-	-	-	-	-	-	-	14		
16		82.5	82.5	82.5	82.5	82.5	-	-	-	-	-	-	-	-	-	-	-	-	16		
18		82.5	82.5	82.5	82.5	82.5	-	-	-	-	-	-	-	-	-	-	-	-	18		
20		82.5	82.5	82.5	82.5	82.5	82.5	-	-	-	-	-	-	-	-	-	-	-	20		
24		82.5	82.5	82.5	82.5	82.5	82.5	82.5	-	-	-	-	-	-	-	-	-	-	24		
28		82.5	82.5	82.5	82.5	82.5	82.5	82.5	80.2	-	-	-	-	-	-	-	-	-	28		
32		82.5	82.5	82.5	82.5	82.5	82.5	82.5	76.5	75.3	-	-	-	-	-	-	-	-	32		
36		-	82.5	82.5	82.5	82.5	82.5	82.5	73.3	72.9	-	-	-	-	-	-	-	-	36		
40		-	82.5	82.5	82.5	82.5	82.5	82.3	70.1	70.2	62.6	54.9	-	-	-	-	-	-	40		
48		-	77.5	82.5	82.5	82.5	82.5	79.3	64.7	62.7	56.7	53.1	45.6	-	-	-	-	-	48		
56		-	-	77.5	78.0	77.5	76.6	71.6	59.3	55.0	50.1	47.7	42.9	36.0	-	-	-	-	56		
64		-	-	53.7	67.5	66.4	64.6	64.8	54.3	48.5	44.5	42.6	39.1	33.2	27.8	24.7	-	-	64		
72		-	-	-	58.0	56.9	55.7	56.2	50.1	42.5	39.6	38.2	35.8	30.5	25.6	22.7	17.4	-	72		
80		-	-	-	-	49.5	50.6	48.8	46.5	38.0	35.1	34.2	32.6	28.1	23.8	20.9	16.9	-	80		
88		-	-	-	-	37.3	44.5	42.7	43.1	34.4	31.3	30.6	29.3	26.0	22.2	19.4	16.4	-	88		
96		-	-	-	-	-	39.5	37.8	38.9	31.2	28.2	27.4	26.2	24.2	20.8	18.2	15.7	-	96		
104		-	-	-	-	-	26.3	35.3	34.7	28.3	25.4	24.6	23.7	22.3	19.6	17.1	14.9	-	104		
112		-	-	-	-	-	-	31.8	30.7	25.7	23.3	22.1	21.3	20.4	18.2	16.0	14.1	-	112		
120		-	-	-	-	-	-	7.5	27.2	23.5	21.4	19.9	19.2	18.7	17.1	15.0	13.3	-	120		
128		-	-	-	-	-	-	-	21.8	21.5	19.5	18.3	17.3	17.0	15.9	14.0	12.5	-	128		
136		-	-	-	-	-	-	-	7.2	19.8	17.8	16.8	15.6	15.2	14.6	13.2	11.8	-	136		
144		-	-	-	-	-	-	-	-	16.5	16.2	15.3	14.2	13.7	13.5	12.4	11.1	-	144		
152		-	-	-	-	-	-	-	-	-	14.6	14.1	13.1	12.6	12.4	11.8	10.3	-	152		
160		-	-	-	-	-	-	-	-	-	-	13.0	12.0	11.6	11.1	11.2	9.4	-	160		
168		-	-	-	-	-	-	-	-	-	-	-	11.1	10.6	10.2	10.3	8.7	-	168		
176		-	-	-	-	-	-	-	-	-	-	-	10.3	9.8	9.6	9.4	8.0	-	176		
184		-	-	-	-	-	-	-	-	-	-	-	-	9.1	8.9	8.6	7.2	-	184		
192		-	-	-	-	-	-	-	-	-	-	-	-	-	8.3	7.8	6.5	-	192		
200		-	-	-	-	-	-	-	-	-	-	-	-	-	7.7	7.0	5.8	-	200		
208		-	-	-	-	-	-	-	-	-	-	-	-	-	3.9	6.2	5.1	-	208		
216		-	-	-	-	-	-	-	-	-	-	-	-	-	3.3	5.3	4.5	-	216		
224		-	-	-	-	-	-	-	-	-	-	-	-	-	-	-	3.9	-	224		
232		-	-	-	-	-	-	-	-	-	-	-	-	-	-	-	3.3	-	232		
240		-	-	-	-	-	-	-	-	-	-	-	-	-	-	-	2.7	-	240		
1)		39.9	30.0	23.1	18.5	14.8	12.1	9.3	7.3	5.3	4.2	2.4	-	-	-	-	-	-	1)		

1) Capacities with horizontal boom

☰ 113,800 lb		📏 27.60 ft x 29.10 ft															360°		85%	
📐		(ft)															📐			
ft		42.0	55.4	68.9	82.3	95.8	109.3	122.7	136.2	149.6	162.4	175.9	190.0	203.4	216.9	230.3	255.9	ft		
		1,000 lb																		
10		82.5	82.5	82.5	-	-	-	-	-	-	-	-	-	-	-	-	-	-	10	
12		82.5	82.5	82.5	82.5	-	-	-	-	-	-	-	-	-	-	-	-	-	12	
14		82.5	82.5	82.5	82.5	-	-	-	-	-	-	-	-	-	-	-	-	-	14	
16		82.5	82.5	82.5	82.5	82.5	-	-	-	-	-	-	-	-	-	-	-	-	16	
18		82.5	82.5	82.5	82.5	82.5	-	-	-	-	-	-	-	-	-	-	-	-	18	
20		82.5	82.5	82.5	82.5	82.5	82.5	-	-	-	-	-	-	-	-	-	-	-	20	
24		82.5	82.5	82.5	82.5	82.5	82.5	82.5	-	-	-	-	-	-	-	-	-	-	24	
28		82.5	82.5	82.5	82.5	82.5	82.5	82.5	80.2	-	-	-	-	-	-	-	-	-	28	
32		82.5	82.5	82.5	82.5	82.5	82.5	82.5	76.5	75.3	-	-	-	-	-	-	-	-	32	
36		-	82.5	82.5	82.5	82.5	82.5	82.5	73.3	72.9	-	-	-	-	-	-	-	-	36	
40		-	82.5	82.5	82.5	82.5	82.5	82.3	70.1	70.2	62.6	54.9	-	-	-	-	-	-	40	
48		-	77.5	80.4	80.8	80.4	79.9	79.3	64.7	62.7	56.7	53.1	45.6	-	-	-	-	-	48	
56		-	-	70.3	71.5	70.3	68.2	69.3	59.3	55.0	50.1	47.7	42.9	36.0	-	-	-	-	56	
64		-	-	51.4	58.9	57.6	58.5	57.0	54.3	48.5	44.5	42.6	39.1	33.2	27.8	24.7	-	-	64	
72		-	-	-	48.7	50.2	48.9	46.8	48.2	42.5	39.6	38.2	35.8	30.5	25.6	22.7	17.4	-	72	
80		-	-	-	-	42.6	41.3	42.7	40.7	38.0	35.1	34.2	32.6	28.1	23.8	20.9	16.9	-	80	
88		-	-	-	-	29.9	36.8	36.7	34.6	33.7	31.3	30.6	29.3	26.0	22.2	19.4	16.4	-	88	
96		-	-	-	-	-	33.1	31.7	29.6	28.7	27.8	26.9	26.2	24.2	20.8	18.2	15.7	-	96	
104		-	-	-	-	-	23.7	27.6	25.9	24.3	24.1	24.1	23.1	22.3	19.6	17.1	14.9	-	104	
112		-	-	-	-	-	-	23.8	22.8	21.3	20.5	20.8	20.0	20.1	18.2	16.0	14.1	-	112	
120		-	-	-	-	-	-	7.5	20.4	19.9	17.9	17.7	18.1	17.2	17.1	15.0	13.3	-	120	
128		-	-	-	-	-	-	-	17.7	17.5	16.1	15.4	15.5	15.5	15.3	14.0	12.5	-	128	
136		-	-	-	-	-	-	-	7.2	15.3	14.3	14.0	13.5	13.9	12.9	13.2	11.8	-	136	
144		-	-	-	-	-	-	-	-	13.1	13.0	12.6	12.4	12.0	12.1	11.8	11.1	-	144	
152		-	-	-	-	-	-	-	-	-	12.2	11.2	11.3	11.0	11.0	9.9	9.7	-	152	
160		-	-	-	-	-	-	-	-	-	-	10.3	10.2	10.2	9.4	8.4	8.1	-	160	
168		-	-	-	-	-	-	-	-	-	-	-	9.1	9.2	8.0	7.1	6.7	-	168	
176		-	-	-	-	-	-	-	-	-	-	-	8.7	8.3	6.8	5.7	5.5	-	176	
184		-	-	-	-	-	-	-	-	-	-	-	-	7.2	5.7	4.6	4.3	-	184	
192		-	-	-	-	-	-	-	-	-	-	-	-	-	5.0	3.5	-	-	192	
200		-	-	-	-	-	-	-	-	-	-	-	-	-	4.4	2.6	-	-	200	
208		-	-	-	-	-	-	-	-	-	-	-	-	-	3.9	-	-	-	208	
216		-	-	-	-	-	-	-	-	-	-	-	-	-	3.3	-	-	-	216	
1)		39.9	30.0	23.1	18.5	14.8	12.1	9.3	7.3	5.3	4.2	2.4	-	-	-	-	-	-	1)	

1) Capacities with horizontal boom

41,200 lb		27.60 ft x 29.10 ft																360°		85%	
		(ft)																			
		42.0	55.4	68.9	82.3	95.8	109.3	122.7	136.2	149.6	162.4	175.9	190.0	203.4	216.9	230.3	255.9				
ft		1,000 lb																ft			
10		82.5	82.5	82.5	-	-	-	-	-	-	-	-	-	-	-	-	-	-	10		
12		82.5	82.5	82.5	82.5	-	-	-	-	-	-	-	-	-	-	-	-	-	12		
14		82.5	82.5	82.5	82.5	-	-	-	-	-	-	-	-	-	-	-	-	-	14		
16		82.5	82.5	82.5	82.5	82.5	-	-	-	-	-	-	-	-	-	-	-	-	16		
18		82.5	82.5	82.5	82.5	82.5	-	-	-	-	-	-	-	-	-	-	-	-	18		
20		82.5	82.5	82.5	82.5	82.5	82.5	-	-	-	-	-	-	-	-	-	-	-	20		
24		82.5	82.5	82.5	82.5	82.5	82.5	82.5	-	-	-	-	-	-	-	-	-	-	24		
28		82.5	82.5	82.5	82.5	82.5	82.5	82.5	80.2	-	-	-	-	-	-	-	-	-	28		
32		82.5	82.5	82.5	82.5	82.5	82.5	82.5	76.5	75.3	-	-	-	-	-	-	-	-	32		
36		-	78.2	78.5	78.1	79.0	77.2	74.1	71.0	68.2	-	-	-	-	-	-	-	-	36		
40		-	71.9	72.6	71.7	73.7	70.1	67.1	65.7	60.5	57.7	53.8	-	-	-	-	-	-	40		
48		-	43.9	53.7	54.3	53.4	55.4	53.3	50.4	48.1	45.2	42.6	39.9	-	-	-	-	-	48		
56		-	-	41.1	42.3	43.1	42.1	40.5	39.7	38.5	36.5	34.3	32.6	30.3	-	-	-	-	56		
64		-	-	21.3	34.3	34.0	32.9	32.2	31.7	30.9	30.4	28.7	26.7	25.6	24.5	23.9	-	-	64		
72		-	-	-	27.7	27.3	26.4	26.1	26.1	25.9	24.6	23.6	23.2	21.9	21.0	19.3	17.4	-	72		
80		-	-	-	-	22.5	22.3	22.7	21.6	20.9	20.5	20.3	19.5	19.5	17.7	15.1	13.8	-	80		
88		-	-	-	-	17.3	19.8	18.7	17.6	17.7	17.5	17.0	17.1	16.1	14.8	11.8	10.5	-	88		
96		-	-	-	-	-	16.5	15.3	15.4	15.0	14.7	14.9	14.1	13.9	11.8	9.0	7.6	-	96		
104		-	-	-	-	-	13.8	13.1	13.3	12.7	13.0	12.2	12.2	11.1	9.3	6.5	5.3	-	104		
112		-	-	-	-	-	-	12.0	11.1	11.6	10.7	10.9	10.0	8.9	7.2	4.5	-	-	112		
120		-	-	-	-	-	-	7.5	9.6	9.8	9.2	9.1	8.2	7.1	5.6	-	-	-	120		
128		-	-	-	-	-	-	-	8.7	8.1	8.2	7.5	6.4	5.4	4.1	-	-	-	128		
136		-	-	-	-	-	-	-	7.2	6.7	6.9	6.0	4.9	4.0	2.7	-	-	-	136		
144		-	-	-	-	-	-	-	-	5.6	5.6	4.7	3.8	2.7	-	-	-	-	144		
152		-	-	-	-	-	-	-	-	-	4.5	3.6	-	-	-	-	-	-	152		
160		-	-	-	-	-	-	-	-	-	-	2.8	-	-	-	-	-	-	160		
1)		39.9	30.0	23.1	18.5	14.8	12.1	9.3	7.3	5.3	4.0	-	-	-	-	-	-	-	1)		

1) Capacities with horizontal boom

0 lb		27.60 ft x 29.10 ft														360°	85%
		(ft)															
ft		42.0	55.4	68.9	82.3	95.8	109.3	122.7	136.2	149.6	162.4	175.9	190.0	203.4		ft	
		1,000 lb															
10		82.5	82.5	82.5	-	-	-	-	-	-	-	-	-	-	-	10	
12		82.5	82.5	82.5	82.5	-	-	-	-	-	-	-	-	-	-	12	
14		82.5	82.5	82.5	82.5	-	-	-	-	-	-	-	-	-	-	14	
16		82.5	82.5	82.5	82.5	82.5	-	-	-	-	-	-	-	-	-	16	
18		82.5	82.5	82.5	82.5	82.5	-	-	-	-	-	-	-	-	-	18	
20		82.5	82.5	82.5	82.5	82.5	82.5	-	-	-	-	-	-	-	-	20	
24		82.5	82.5	82.5	82.5	81.8	80.7	79.5	-	-	-	-	-	-	-	24	
28		75.6	78.7	78.9	76.6	72.7	71.2	66.4	59.2	-	-	-	-	-	-	28	
32		58.2	63.6	65.2	64.6	62.6	57.7	53.9	50.9	45.4	-	-	-	-	-	32	
36		-	50.3	52.1	54.4	52.4	48.1	45.7	42.5	41.2	35.0	-	-	-	-	36	
40		-	40.3	42.8	43.6	43.2	41.0	39.5	36.9	34.4	33.9	32.0	-	-	-	40	
48		-	16.6	29.7	30.3	30.1	31.7	29.4	27.9	26.7	26.7	25.1	23.9	-	-	48	
56		-	-	22.1	23.0	23.7	23.2	22.7	22.2	22.1	20.9	20.1	18.0	16.0	-	56	
64		-	-	15.8	17.5	17.8	18.2	18.1	17.9	17.2	17.0	15.4	13.4	11.5	-	64	
72		-	-	-	13.3	14.0	14.4	14.2	14.0	13.1	13.1	11.5	9.6	7.6	-	72	
80		-	-	-	-	11.0	11.0	11.0	10.6	9.9	9.9	8.4	6.6	4.7	-	80	
88		-	-	-	-	8.4	8.4	8.4	8.0	7.1	7.3	6.0	4.2	-	-	88	
96		-	-	-	-	-	6.3	6.3	5.7	5.0	5.2	4.0	-	-	-	96	
104		-	-	-	-	-	4.6	4.4	3.9	3.3	3.3	2.4	-	-	-	104	
1)		37.7	22.7	15.2	10.4	6.8	4.0	-	-	-	-	-	-	-	-	1)	

1) Capacities with horizontal boom

Ratings are in compliance with ASME B30.5.
Lifting capacities do not exceed 85 % of tipping load.

Consult operation manual for further details.

Note: Data published herein is intended as a guide only and shall not be construed to warrant applicability for lifting purposes. Crane operation is subject to the computer charts and operation manual both supplied with the crane.

Basic machine

Equipment carrier

Engine 368-4	Scania DC13; Diesel engine; 368 kW / 2100 1/min (500 HP), torque 2373 Nm / 1300 1/min; The engine complies with Euromot 4/Tier 4F; Exhaust system complete stainless steel.
Fuel tank	Fuel tank 132 gallons Diesel (no RME / biodiesel); 16 gallons AdBlue tank.
Transmission AS12INT	ZF AS-Tronic; Automated gearbox with integrated hydraulic retarder, 12 forward speeds and 2 reverse; 2-stage transfer case with switchable off-road gear.
Axles 10 x 6 x 10	10 x 6 x 10; Five axles, axles 3-5 are driven and dispose of a selectable transverse lock; Axle 4 with selectable longitudinal lock; All axles steered.
Suspension	Hydropneumatic suspension with axle load compensation; Hydraulically lockable.
Steering	Dual-circuit steering system with independent rear axle steering; Axles 1, 2, 3 mechanically connected; Axles 4 and 5 electro-hydraulically connected, all axles steered with 6 different steering programs.
Brakes	Pneumatic dual circuit service brake, acting on all wheels; Disc brakes; Hydraulic retarder integrated into transmission as wear-free sustained-action brake; Additional exhaust brake; Parking brake.
Tires size 385/95 R25 (14.00R25)	Tires size 385/95 R25 (14.00R25); Steel rim 9,5-25/1,7".
Cab 2850	S-PACE type 9.35 ft; Adjustable driver seat, armrests and pneumatic suspension; Height and tilt-adjustable steering wheel; Auxiliary / passenger seat; Powered door windows; Tinted glass; Central door locking; Electrically adjustable rear-view mirrors, heated; Preparation for radio.
Heating engine-dependent	Engine-dependent warm water heating with 12 kW heating power.
Drive lights	Including low beams, high beams, daytime running lights.
Outriggers	H-4-point design; Vertical and horizontal movement fully hydraulic; Manual or automatic levelling alternatively; 4 outrigger bases: 9.0 ft, 18.2 ft, 23.0 ft, 27.6 ft.
Outrigger pads 038PA	4 round polyamide outrigger pads A = 1.25 ft ² with transport position at vertical cylinder.
Outrigger basis monitoring	Individual monitoring of horizontal stroke; Deviation warning in crane cab.
Outrigger load indicator	The outrigger load is indicated in the operator cab and the outrigger control box.
Electronic immobilizer system	Prevents uncontrolled carrier mobilization; Incl. 5 ignition keys.
Pneumatic tire filling plug	Pneumatic system adapter for inflating tires makes it possible for operators to inflate tires by themselves.
Contour safety marking	Continuous reflective strips on the sides of the chassis and on the rear.

Equipment superstructure

Telescopic boom HA78	42.0 ft - 255.9 ft; Single cylinder telescoping system, automatic telescoping; Attachments for all equipment and extensions; 4 sheaves integrated in boom head for max. capacity of 168,900 lb.
Boom luffing	1 luffing cylinder with automatic lowering brake valve.
Rotary drive	Single slewing gear unit with spring-loaded multi-disc brake; Different operating modes selectable.
H1	Hoist with spring-loaded multi-disc brake; Resolver (hoist rotation indicator); Rope twist prevention is not included.
Counterweight 113,800 lb	Counterweight 113,800 lb, 6 pieces (a-e); Automatic rigging system.
Control system	Enabling 4 simultaneous working movements; Electric pilot controls via 2 two-axis joysticks; Different control modes selectable for hydraulic circuits.
Operator aids	IC-1, with integrated electronic load moment indicator in accordance with EN13000; Color display; Displaying of current operating conditions, load charts, fault indicator; Signal lights indicating LMI-load; Crane data logger.
Hook height indication	Displaying and programmability of the hook height H1 and /or H2 by IC-1.
Cab 875	S-PACE type 875; Tilt infinitely variable 16°; Sliding window rear; Fold-out front window; Extendable side pedestal, front pedestal; Handrails; Tinted safety glass; Pull-down sun visor; Preparation for radio.
Heating engine-independent	Engine-independent warm water heating with 5 kW heating power.
Anemometer	Removable, to be used with all extensions.

Additional equipment

Carrier

Engine 331-3	Scania DC13; Diesel engine; 331 kW / 2100 ¹ /min (450 HP), torque 2007 Nm / 1575 ¹ /min; The engine complies with Euromot 3a / Tier 3; Exhaust system optional with spark arrester.
Axles 10 x 8 x 10	10 x 8 x 10; Five axles, axles 2-5 are driven and dispose of a selectable transverse lock; Axles 3 and 4 with selectable longitudinal lock; All axles steered.
Additional fuel tank	Additional fuel tank 53 gallons; For 185 gallons diesel total in carrier (no RME / biodiesel).
Aircondition	Aircondition for carrier cab, 7 kW rated cooling power.

Superstructure

Additional sheave on main boom head	1 additional sheave; Dis-/connectable; For total 5 sheaves at boom head; Max. capacity 209,000 lb.
Heavy lift attachment 2. hoist (H2)	2 additional sheaves; Dis-/connectable; For total 7 sheaves at boom head; Max. capacity 286,600 lb. 2. hoist; Spring-loaded multi-disc brake; Integrated resolver (hoist rotation indicator); Incl. quick couplings and transport rack; Rope twist prevention is not included.
Additional counterweight 41,000 lb	Additional counterweight 41,000 lb; 2 pieces; for total 154,800 lb, 8 pieces.
Aircondition	Aircondition in crane cab with 5 kW rated cooling power.

Handling

Remote control	Control of superstructure movements via wireless remote control.
Working range limiter IC-1 Plus	Displaying and programmability of the work range limits by IC-1. Smart crane control system for main boom operation enabling higher lifting capacities especially over outriggers. Enables safe use of the full capacity of the crane even in asymmetric outrigger configurations. Outriggers can be positioned independently. Capacity precalculation for +/- 30° slewing angle and radius area. In-cab lift simulation.

Extensions

HAV 36.1 ft	37.4 ft; Lattice swing-away jib, manually offsettable 20°/40°; 1-sheaved head; Incl. transport storage; Cannot be carried while maintaining 26,500 lb axle load.
HAV 68.9 ft	68.9 ft; Double folding swing-away jib, manually offsettable 20°/40°; 1-sheaved head; Incl. transport storage; Cannot be carried while maintaining 26,500 lb axle load; Includes HAV 36.1 ft.
HAV-HY	Hydraulic offset 0°-40° instead of manual offset 20°/40°; available for HAV 36.1 ft, HAV 68.9 ft.
MS (runner)	5.25 ft; Fixed angle runner; 2 sheaves, for max. 86,200 lb lifting capacity; Incl. transport storage at boom head.

Hook Blocks

Hook block 160-7-21-D-1500	160-7-21-D (3310 lb); Hook block with ramshorn hook; white with red signal stripes.
Hook block 125-5-21-D-1125	125-5-21-D (2480 lb); Hook block with ramshorn hook; white with red signal stripes.
Hook block 80-3-21-D-850	80-3-21-D (1870 lb); Hook block with ramshorn hook; white with red signal stripes.
Hook block 32-1B-21-D-Vario	32-1B-21-D (441 lb / 1320 lb); Hook block with ramshorn hook, ballast transported separately on rear of carrier, requires storage; white with red signal stripes.
Hook block 32-1-21-D-600	32-1-21-D (1320 lb); Hook block with ramshorn hook; white with red signal stripes.
Hook 12-0V-E-350	12-0V-E (770 lb); Single hook with vertical swivel; red.

Further additional equipment on request!

Weight data may deviate from posted values based on road / travel configuration, equipment configuration, and component weight tolerances.

A large rectangular area with horizontal lines, intended for taking notes.

A large rectangular area with horizontal lines, intended for taking notes.

August 2017. Product specifications and prices are subject to change without notice or obligation. The photographs and/or drawings in this document are for illustrative purposes only. Refer to the appropriate Operator's Manual for instructions on the proper use of this equipment. Failure to follow the corresponding Operator's Manual when using our equipment or to otherwise act responsibly may result in serious injury or death. The only warranty applicable to our equipment is the standard written warranty applicable to the particular product and sale and Terex makes no other warranty, express or implied. Products and services listed may be trademarks, service marks or trade-names of Terex Corporation and/or its subsidiaries in the USA and other countries. All rights are reserved. Terex, Demag and Above, Ahead, Always are trademarks of or licensed by Terex Corporation or its subsidiaries.

© Terex Cranes 2017

TEREX CRANES GERMANY GMBH

Dinglerstraße 24
66482 Zweibrücken
Germany

E info.cranes@terex.com
T +49 6332 830

www.terex.com/cranes
linkedin.com/company/demagmobilecranes
facebook.com/TerexCranes
youtube.com/TerexCranesMarketing

DEMAG[®]
BY TEREX 