



SCC1800A

Crawler Crane 180 Tons Lifting Capacity

Quality Changes the World



Max. lifting moment: $132 \times 8 = 1056 \text{t} \cdot \text{m}$
Max. boom length: 82m
Max. fixed jib combination: 70m+31m
Max. luffing jib combination: 52m+52m

The parameters and diagrams in the brochure is only for reference, which is subject to further update in real machine.

■ www.sany.com.cn

Version: V1.0



Crawler Crane Series
SCC1800A

P03

Main
Characteristics

- Product Specification
- Safety Device

P09

Technical
Parameters

- Major Performance & Specifications
- Outline Dimension
- Transport Dimension
- Transport Plan

P19

Cofigurations

- H Configuration
- FJ Configuration
- LJ Configuration



SCC1800A
SANY CRAWLER CRANE
180 TONS LIFTING CAPACITY

QUALITY CHANGES THE WORLD

Main Characteristics

- Page 04 Product Specification
- Page 07 Safety Device



Product Specification



Engine

- Model: DCEC (Cummins China) QSL8.9-C325 Diesel engine;
- Type: 4-stroke, water-cooled, vertical in-line 6 cylinders, direct injection, turbo-charger, intercooler, complied with European Off-way Tier III Emission Standard and Chinese Off-way Tier III Emission Standard;
- Displacement: 8.9L;
- Rated power: 242kW/2100rpm;
- Operation power: 234kW/1800rpm;
- Max. Torque: 1385N·m/1500rpm;
- Starter: 24V-6.0kW;
- Radiator: fin type aluminum plate core;
- Air cleaner: Dry type system with main filter element, safety element and resistance indicator;
- Throttle: Grip type hand throttle, electrically-controlled;
- Fuel filter: Replaceable paper element;
- Batteries: Two 12V×180Ah capacity batteries, connected in series;
- Fuel tank capacity: 400L.

Electrical Control System

- Self-developed SYIC-II integrated control system is adopted with higher integration, precise operation and reliable quality;
- Control system consists of power system, engine system, main control system, LMI system, auxiliary system and safety monitoring system. CAN BUS is used for data communication between controller, monitor and the engine;
- Monitor: the working parameters and status are shown on the monitor, such as the engine speed, fuel volume, engine oil pressure, servo pressure, wind speed, engine working hours, lifting conditions and boom angle.

Hydraulic System

- Main pumps: open variable displacement piston pumps of large displacement are adopted to provide oil supply for main actuators of main machine;
- Gear pump: dual gear pump for radiator and control circuit;
- Control: main pump adopts electrically-controlled positive flow control; winch motor adopts limitless adjustable piston motor of variable displacement. The operating components are two cross hydraulic handle, one dual travel pedal control valve to control various actuators proportionally;
- Way of cooling: heat exchanger, fan core and multi-stage cooling;
- Filter: large flow, high precision filter, with bypass valve and transmitter, which can remind the user to replace the filter element in time;
- Max. pressure of system: 32 MPa;
- Main/aux. load hoist, boom hoist, swing and travel system: 32MPa;
- Control system: 5 MPa;
- Hydraulic Tank Capacity:460L.

Main and Auxiliary Load Hoist Mechanism

- Main and aux. hoist winches are driven separately by motor via gearbox. Operating winch handle can control the winch to rotate to two directions, which are lifting and lowering of hook. Excellent inching function is equipped on the machine;
- Drums with fold-line grooves can ensure the wire rope reeved in order in multilayers;
- Free fall for main/aux. load hoist is offered as optional, with rated single line pull of 12t.

Main Hoisting Mechanism	Drum diameter	630mm
	Rope speed (5th layer)	0-130m/min
	Diameter of wire rope	26mm
	Main load hoist wire rope length	390m
	Rated single line pull	13.5t
Auxiliary Hoisting Mechanism	Drum diameter	630mm
	Rope speed (5th layer)	0-130m/min
	Diameter of wire rope	26mm
	Auxiliary load hoist wire rope length	300m
	Rated single line pull	13.5t



Product Specification

Boom Hoist Mechanism

- Boom hoist winch is driven directly by motor via gearbox. Operating winch handle can control the winch to rotate to two directions, which are lifting and lowering of boom;
- Drums with fold-line grooves can ensure the wire rope reeved in order in multilayers.

Boom hoist mechanism	Drum diameter	440mm
	Rope speed (5th layer)	0~46m/min
	Diameter of wire rope	22mm
	Boom hoist wire rope length	250m
Jib hoist mechanism	Drum diameter	500mm
	Rope speed (5th layer)	0~46m/min
	Diameter of wire rope	22mm
	Jib hoist wire rope length	190m

Swing Mechanism

- Swing brake adopts wet, spring loaded, normally-closed brake, and braking through spring force;
- Swing system, equipped with integrated swing buffer valve, has free slipping function. It is featured in steady starting and control, and excellent inching function. Unique swing buffer design and steadier brake;
- Swing drive: internal engaged swing drive with 360° swing range, and the max. swing speed is 1.3r/min. The max. drive pressure can reach 32MPa;
- Swing ring: three-row roller bearing.

Cab and Control

- Novel operator's cab with fashionable profile, nice interior and large window glass, which can shift horizontally and tilt up and down. There are low and high-beam lights, back-view mirror, heater and A/C, radio and other functions. The layout of seat, handles, control buttons are designed with ergonomic principles to make operation more comfortable;
- Cab layout: Integrated 10.4-inch touch screen, programmable smart switches, and man-machine interaction interface are more perfect;
- Armrest box: on the left and right armrest box are control handles, electrical switches, emergent stop and ignition switch. The armrest box can be adjusted along with the seat;
- Seat: multi-way and multi-level floating adjustable seat with unload switch;
- A/C: cool and heat air; optimized air channels and vents;
- Multiple cameras can present on the monitor at the same time to realize backing video, real-time monitoring of wire rope on each winch, conditions behind the counterweight and surrounding the machine.

Counterweight

- The stacking mode of counterweight tray and blocks is used for easy assembly, disassembly and transportation;
- Rear counterweight: total weight 68t. There are two types, one is regular counterweight as standard offering ; and self-assembly counterweight as optional offering. Counterweight block 6t x 8, counterweight block 3t x 2, and counterweight tray of 14t;
- Carbody counterweight: total weight 20t, 10t x 2.

Upperworks

- High-strength steel weld framework, with no torsion or deformation. The parts are laid out in the way that is easier for maintenance and service.

Product Specification



Lowerworks

- Independent travel driving units are adopted for each side of the crawler, to realize straight walking and turning driven by travel motor through gearbox and drive wheel.

Crawler Tightening

- The jack is used to push the guide wheel and insert the shim to adjust crawler tension.

Track Pad

- High strength alloy cast steel track pad ensure long service life;
- The track pads are 1100mm wide, a total of 70 pcs ×2.

Operating Equipment

- All chords are high-strength steel tubes, and the boom/jib top sheaves are made of high-strength anti-wearing Nylon material protecting wire rope. The hooks are installed with milled welded steel sheave.

Boom

- Lattice structure. The chord adopts high-strength structural tube and each section is connected through pins;
- Basic boom: 8m boom base + 8m boom top;
- Boom insert: 3m×2, 6m×2, 12m×4;
- Boom length: 16m~82m.

Fixed Jib

- Lattice structure. The chord adopts high-strength structural tube and each section is connected through pins;
- Basic jib: 5m jib base +3m insert +5m jib top;
- Jib insert: 6m×3;
- Fixed jib: 13m~31m;
- Longest boom + jib: 70m +31m.

Luffing Jib

- Lattice structure. The chord adopts high-strength structural tube and each section is connected through pins;
- Basic jib: 6.5m jib base +9m insert +6.5m jib top;
- Jib insert: 3m×2, 6m×1, 9m×2;
- Longest boom + jib: 52m +52m.

Extension Jib

- The welding structure is connected with main boom through hinge pin, and used for aux. hook operation;
- Length of extension boom: 1.5m.

Hook Block

- 180t hook, 7 pulleys;
- 100t Hook, 5 pulleys;
- 50t Hook, 3 pulleys;
- 13.5t, ball hook.



Safety Device

Assembly/Work Mode Control Switch

- Under the assembly mode, over-hoist limit switch, crane boom limit device and load moment limiter do not work, so as to facilitate the installation of crane;
- All safety limit devices work in the work mode.

Emergency Stop

- In emergent situation, this button is pressed down to cut off the power supply of whole machine and all actions stop.

Load Moment Limiter (LMI)

- It is an independent computerized safety control system. LMI can automatically detect the load weight, work radius and boom angle, and present on the display the rated load, actual load, work radius and boom angle. In normal operation, the LML can make a judgment and cut off automatically if the crane moves towards dangerous direction. It can also perform as a black box to record the lifting information;
- It is composed of monitor, angle sensor and force sensor and other parts.

Over-hoist Limit Switch of Main/Auxiliary Hooks

- Over-hoist protection device comprises of limit switch and weight on boom top, which prevents the hook lifting up too much;
- When the hook lifts up to the limit height, the limit switch activates, buzzer on the left control panel sends alarm, failure indicator light starts to flash, and the hook hoisting action is cut off automatically, cut off automatically.

Over-release Limit Switch of Main/Auxiliary Hooks

- It is comprised of activator in the drum and proximity switch to prevent over release of wire rope. When the rope is paid out close to the last three wraps, the limit switch acts, and the system sends alarm through buzzer and show the alarm on the instrument panel, automatically cutting off the winch action.

Function Lock Lever

- If the function lock level is not in work position, all the other handles won't work, which prevents any mis-operation caused by accidental collision.

Boom Hoist Drum Lock

- Pawl lock is used on boom hoist winch, which needs to unlock by switch before operation, in order to prevent mis-operation of handles and ensure safety during nonwork time.

Swing Lock Device

- Swing Lock can lock the machine at four positions, front and back, left and right.

Boom Limit Device

- When the boom elevation angle reaches the max. set limit, the buzzer sounds and boom action cut off. This protection is two-stage control ensured by both LML system and travel switch;
- Back-stop Device;
- Its major components are nesting tubes and spring, in order to buffer the boom backlash and prevent further tipping back;
- Boom Angle Indicator;
- Pendulum angle indicator is fixed on the side of boom base close to the cab, so as to provide convenience to the operator.

Hook Latch

- The hook is provided with a baffle to prevent wire rope from falling off.

Safety Device



Lightning Protection Device

- It is offered as an optional feature, which includes the grounding device that can effectively protect the electric system elements and workers from lightning.

Tri-color Load Indicator

- The load indication light has three colors, green, yellow and red, and the real time load status is presented on the display. When the actual load is smaller than 90% of rated load, the green light is on;
- When the actual load is larger than 90% and smaller than 100%, the yellow light is on, the alarm light flashes and sends out intermittent sirens;
- When the actual load reaches 100% of rated load, the red light is on, the alarm light flashes and sends out continuous sirens;
- When the actual load reaches 102% of rated load, the system will automatically cut off the crane operation in dangerous trend.

Audio-visual Alarm

- When the engine is working, the light flashes; when the machine is traveling or swinging, it sends out sirens.

Swing Indicator Light

- The swing indicator light flashes during traveling or swing.

Illuminating Light

- The machine is equipped with the low beam light and high beam light at the front of the cab, illumination light at cab, and other night lights, boom lights to improve the visibility during construction.

Rearview Mirror

- Separately set on the left front of the cab and on the handrail at the front of right sheet metal, so as to monitor the rear part of machine.

Pharos

- Pharos is mounted on the top of boom/jib to indicate the height.

Anemometer

- It is mounted on the top of boom/jib, and displayed on the monitor in the cab.

Electronic Level Indicator

- It displays the tipping angle of crane on the monitor in real time, protecting the machine from dangerous situation.

Seat Interlock

- Put down the function lock lever on the left side of cab seat or if the operator leaves the seat, all control levers will be deactivated to prevent any mis-operation due to accidental collision.

Engine Power Limit Load Adjustment and Stalling Protection

- The controller monitors the engine power to prevent engine getting stuck and stalling.

Engine Status Monitoring

- The engine status will be presented, such as engine coolant temperature, fuel volume, total work hours, engine oil pressure, engine speed, battery charging, voltage.



SCC1800A
SANY CRAWLER CRANE
180 TONS LIFTING CAPACITY

QUALITY CHANGES THE WORLD

Technical Parameters

- Page 10 Major Performance Specifications
- Page 11 Outline Dimension
- Page 12 Transport Dimension
- Page 17 Transportation Plan



Major Performance Specifications

Major Performance & Specifications of SCC1800A			
Performance Indicators		Unit	Parameter
Boom configuration	Maximum rated lifting capacity	t	180
	Maximum rated lifting moment	t·m	1056(=132×8)
	Boom length	m	16~82
Fixed jib configuration	Maximum rated lifting capacity	t	34
	Jib length	m	13~31
	Longest main boom + jib	m	70+31
Luffing jib configuration	Maximum rated lifting capacity	t	61.3
	Jib length	m	22~52
	Longest main boom + luffing jib	m	52+52
Operation speed	Rope speed of main/aux. load hoist (5th layer)	m/min	0~130
	Boom hoist winch rope speed (5th layer)	m/min	0~46
	Slewing speed	rpm	0~1.3
	Travelling speed	km/h	0~1
Engine	Output power	kW	242
	Rated speed	rpm	2100
Transport parameter	Max. transport weight of basic machine (with boom base)	t	45
	Maximum transport dimension of basic machine (L x W x H, mm)	mm	17500×3000×3250
Other parameters	Average ground bearing pressure	MPa	0.118
	Grade ability	%	30

Unit: mm

Outline Dimension

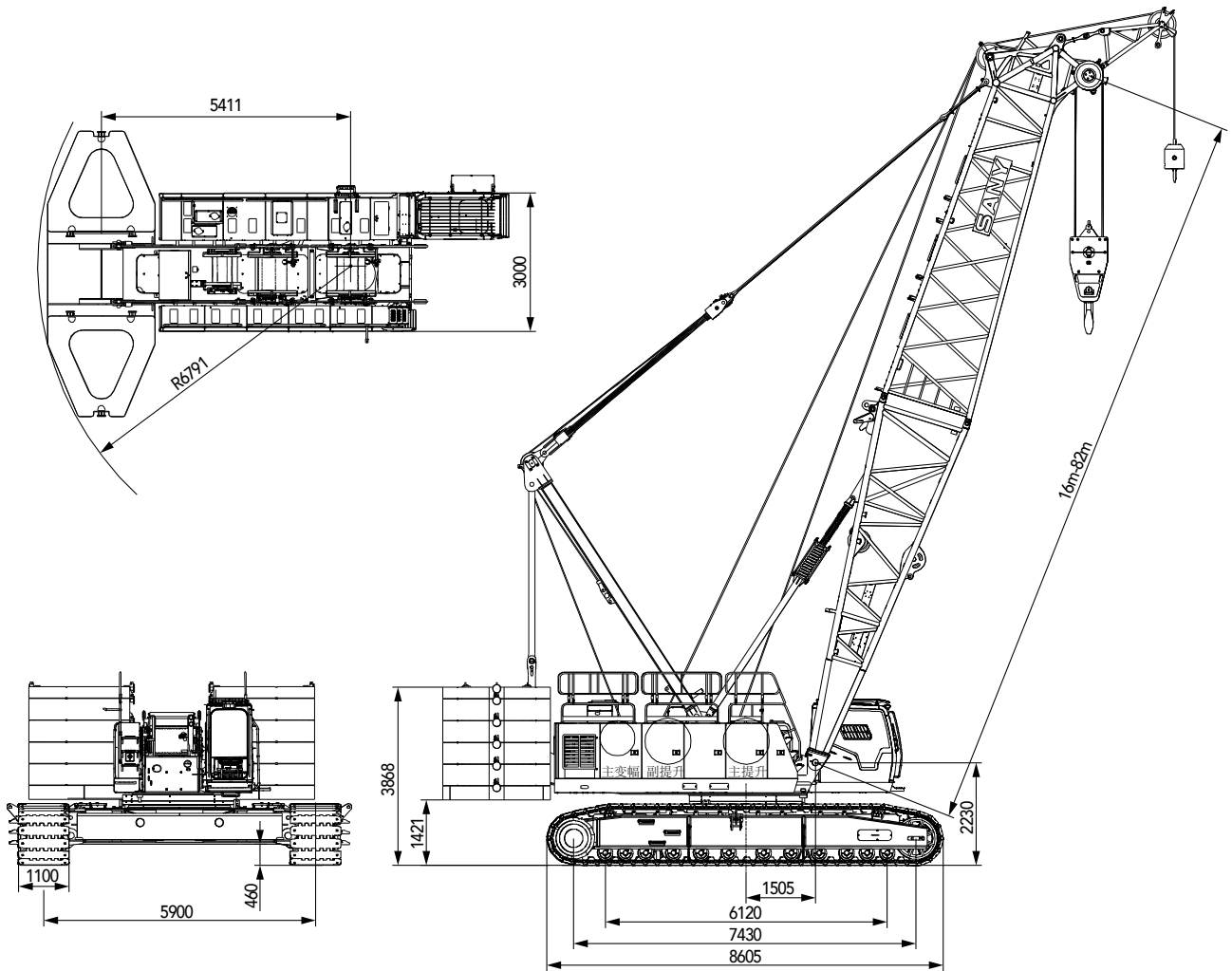

Transportation Dimensions

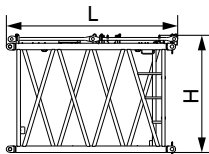
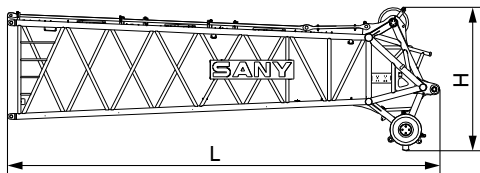
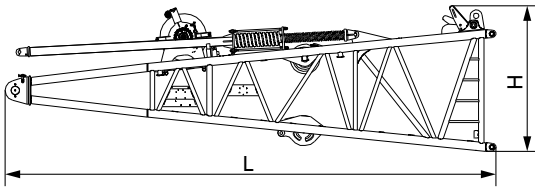
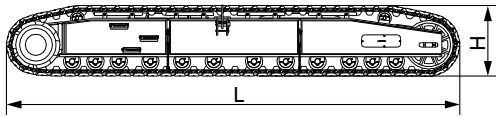
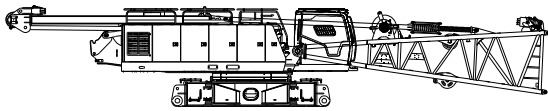
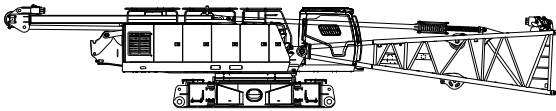

Basic Machine (Mode 1: with boom base, no reeving winch or jib luffing winch) ×1

Length(L)	17.5m
Width(W)	3.00m
Height(H)	3.25m
Weight	43.2t

Basic Machine (Mode 2: with boom base, optional reeving winch and jib luffing winch) ×1

Length(L)	17.5m
Width(W)	3.00m
Height(H)	3.25m
Weight	45t

Note: the above two modes are machine with regular counterweight as standard offering.

Crawler Assembly ×2

Length(L)	8.58m
Width(W)	1.46m
Height(H)	1.34m
Weight	19.5t

Boom base (with jib luffing winch) ×1

Length(L)	8.24m
Width(W)	2.37m
Height(H)	2.44m
Weight	5.44t

Note: the weight of jib luffing winch is 1.25t

Boom Top ×1

Length(L)	8.77m
Width(W)	2.22m
Height(H)	2.91m
Weight	3.06t

3m Boom insert ×2

Length(L)	3.18m
Width(W)	2.27m
Height(H)	2.17m
Weight	0.79t

Transportation Dimensions

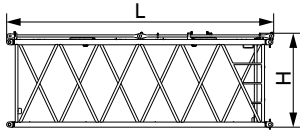

6m Boom insert × 2

Length(L)	6.18m
Width(W)	2.27m
Height(H)	2.17m
Weight	1.27t

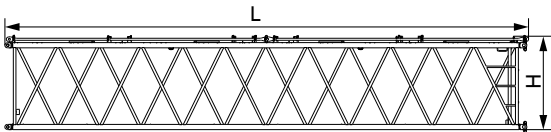

12m Boom insert × 4

Length(L)	12.18m
Width(W)	2.27m
Height(H)	2.17m
Weight	2.36t

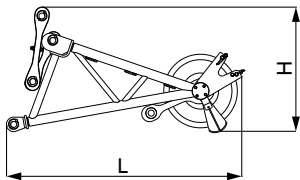

Extension jib × 1

Length(L)	1.96m
Width(W)	0.76m
Height(H)	1.03m
Weight	0.24t

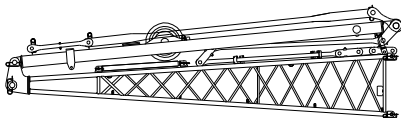

Fixed jib base (with strut and tapered pendant strap) × 1

Length(L)	5.19m
Width(W)	2.16m
Height(H)	1.66m
Weight	1.12t

Note: the weight of the strut is 0.44t, and the tapered pendant strap is 0.11t

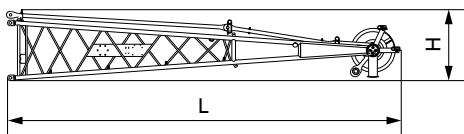

Fixed jib top × 1

Length(L)	5.43m
Width(W)	1.01m
Height(H)	0.99m
Weight	0.53t

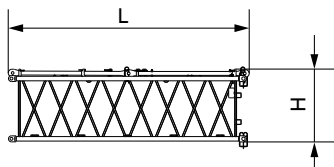

3m fixed jib insert × 1

Length(L)	3.12m
Width(W)	1.02m
Height(H)	0.92m
Weight	0.19t

Transport Dimensions

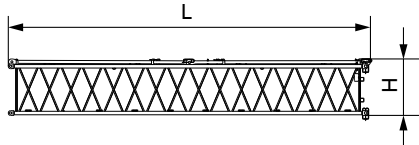

6m fixed jib insert

× 3

Length(L)	6.12m
Width(W)	1.02m
Height(H)	0.92m
Weight	0.34t

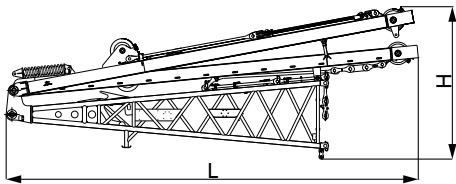

Luffing jib base (with strut)

× 1

Length(L)	8.55m
Width(W)	2.19m
Height(H)	3.16m
Weight	4.5t

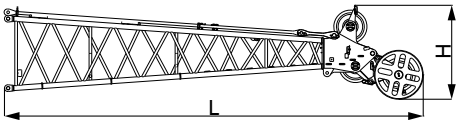

Luffing jib top (with extension jib)

× 1

Length(L)	7.75m
Width(W)	1.61m
Height(H)	1.85m
Weight	1.5t

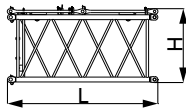

3m luffing jib insert

× 2

Length(L)	3.14m
Width(W)	1.61m
Height(H)	1.54m
Weight	0.48t

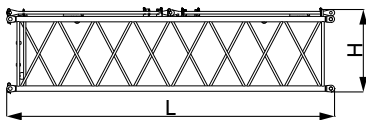

6m luffing jib insert

× 1

Length(L)	6.14m
Width(W)	1.61m
Height(H)	1.54m
Weight	0.79t

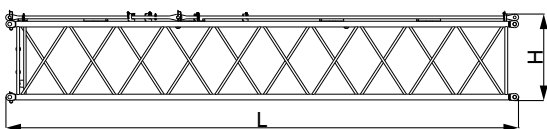

9m luffing jib insert

× 3

Length(L)	9.14m
Width(W)	1.61m
Height(H)	1.54m
Weight	1.08t

Transportation Dimensions

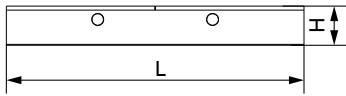

Carbody Counterweight × 2

Length(L)	4.55m
Width(W)	1.35m
Height(H)	0.59m
Weight	10t

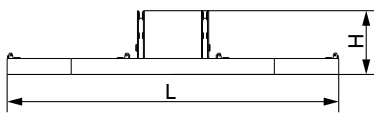

Counterweight tray for regular counterweight (standard offering) × 1

Length(L)	6.2m
Width(W)	2.33m
Height(H)	1.2m
Weight	14t

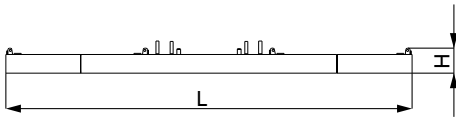

Counterweight tray for self-assembly counterweight (optional offering) 1

Length(L)	6.52m
Width(W)	2.33m
Height(H)	0.52m
Weight	14t

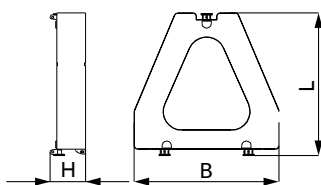

Counterweight block 1 × 8

Length(L)	2.29m
Width(W)	2.33m
Height(H)	0.57m
Weight	6t

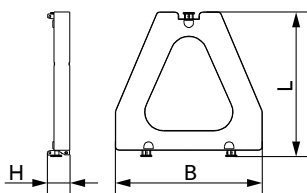

Counterweight block 2 × 2

Length(L)	2.29m
Width(W)	2.33m
Height(H)	0.35m
Weight	3t

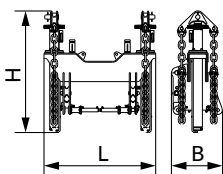

Self-assembly counterweight bracket (optional, with cylinder and chains) × 1

Length(L)	2.02m
Width(W)	0.92m
Height(H)	2.20m
Weight	1.82t

Transport Dimensions

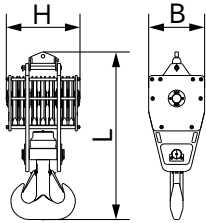

180t Hook

×1

Length(L)	2.45m
Width(W)	0.82m
Height(H)	1.08m
Weight	2.95t

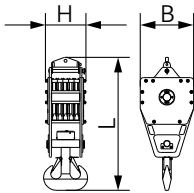

100t Hook

×1

Length(L)	2.36m
Width(W)	0.93m
Height(H)	0.84m
Weight	1.99t

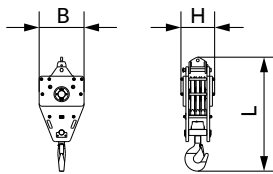

50t Hook

×1

Length(L)	1.95m
Width(W)	0.89m
Height(H)	0.47m
Weight	1.06t

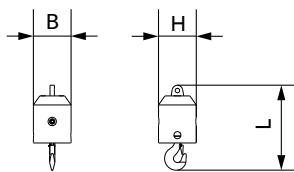

13.5t Ball hook

×1

Length(L)	0.95m
Width(W)	0.43m
Height(H)	0.43m
Weight	0.45t

Remarks:

- 1.The transport dimensions for the parts are for reference that do not draw to the scale. The dimensions listed above are design values excluding packing.
- 2.Weight is design values. It maybe different due to manufacturing tolerances.

Transport Plan

Trailer 1	<ul style="list-style-type: none"> 50t low deck trailer, 13.5m long, 3m wide
Part(s)	<ul style="list-style-type: none"> Basic Machine (with four winches, carbody assembly, A-frame, wire rope) 39.53t Boom base (include jib hoist winch and jib hoist wire rope) 5.44t Boom base outer pendant strap 0.03t
Weight	<ul style="list-style-type: none"> Total: 45t

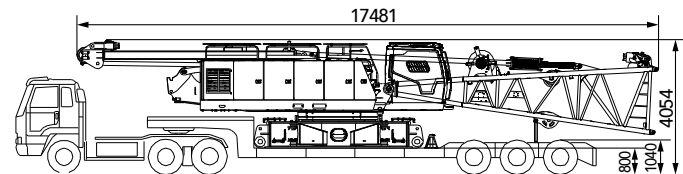

Trailer 2	<ul style="list-style-type: none"> 35t trailer, 17.5m long, 3m wide
Part(s)	<ul style="list-style-type: none"> boom top 3.06t Extension jib 0.24t Luffing jib base with struts 4.5t 180t hook block, 2.95t 100t hook block, 1.99t Boom top outer pendant bar 0.24t Packing case 1t
Weight	<ul style="list-style-type: none"> Total: 13.98t

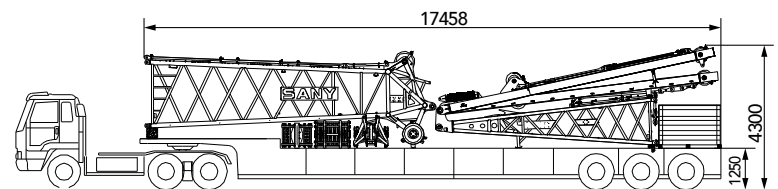

Trailer 3	<ul style="list-style-type: none"> 35t trailer, 17.5m long, 3m wide
Part(s)	<ul style="list-style-type: none"> 12m boom insert, 2.36t 6m boom insert, 1.27t 9m luffing jib insert, 1.08t 3m luffing jib insert, 0.48t 6m fixed jib insert, 0.34t Rear counterweight 1*4, 24t 50t hook block, 1.06t 13.5t ball hook, 0.45t
Weight	<ul style="list-style-type: none"> Total: 31.04t

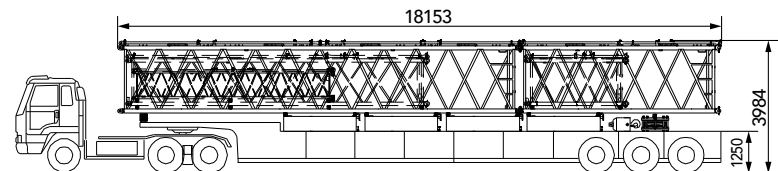

Trailer 4	<ul style="list-style-type: none"> 35t trailer, 17.5m long, 3m wide
Part(s)	<ul style="list-style-type: none"> 12m boom insert, 2.36t 6m boom insert, 1.27t 9m luffing jib insert, 1.08t 3m luffing jib insert, 0.48t 6m fixed jib insert, 0.34t Rear counterweight 1*4, 24t 12m boom outer pendant strap, 0.34t 6m boom outer pendant strap, 0.19t
Weight	<ul style="list-style-type: none"> Total: 30.06t

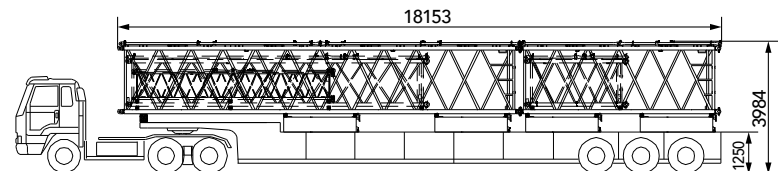

Transport Plan

Trailer 5	<ul style="list-style-type: none"> 35t trailer, 17.5m long, 3m wide
Part(s)	<ul style="list-style-type: none"> 12m boom insert, 2.36t 3m boom insert, 0.79t 9m luffing jib insert, 1.08t 6m fixed jib insert, 0.34t Rear counterweight tray 14t Tapered pendant strap, 0.11t 12m boom outer pendant strap, 0.34t 3m boom outer pendant strap, 0.11t
Weight	<ul style="list-style-type: none"> 19.13t

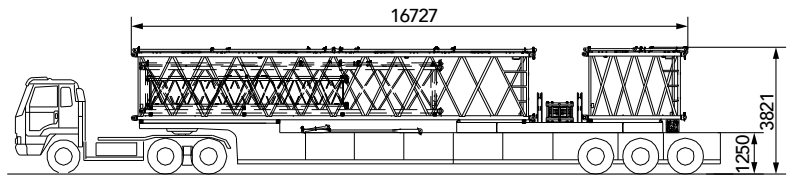

Trailer 6	<ul style="list-style-type: none"> 35t trailer, 17.5m long, 3m wide
Part(s)	<ul style="list-style-type: none"> 12m boom insert, 2.36t 3m boom insert, 0.79t 6m luffing jib insert, 0.79t Fixed jib base with strut without tapered pendant bar, 1.01t Fixed jib top, 0.53t 3m fixed jib insert 0.19t Carbody counterweight x2, 20t Rear counterweight 2*2.6t 3m boom outer pendant strap, 0.11t
Weight	<ul style="list-style-type: none"> 31.78t

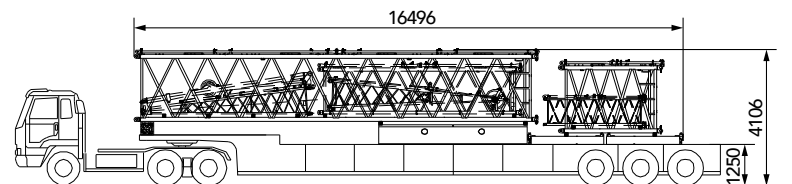

Trailer 7	<ul style="list-style-type: none"> 45t trailer, 17.5m long, 3m wide
Part(s)	<ul style="list-style-type: none"> Left and right track frame (stagger the position), 39t Luffing jib top with extension jib, 1.5t
Weight	<ul style="list-style-type: none"> 40.5t

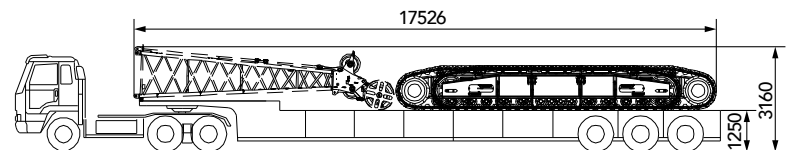

Note: The transport plan is for crane with regular counterweight of standard offering.



SCC1800A
SANY CRAWLER CRANE
180 TONS LIFTING CAPACITY

QUALITY CHANGES THE WORLD

Cofigurations

- Page 21 H Configuration
- Page 25 FJ Configuration
- Page 35 LJ Configuration

> 19

Boom Combination

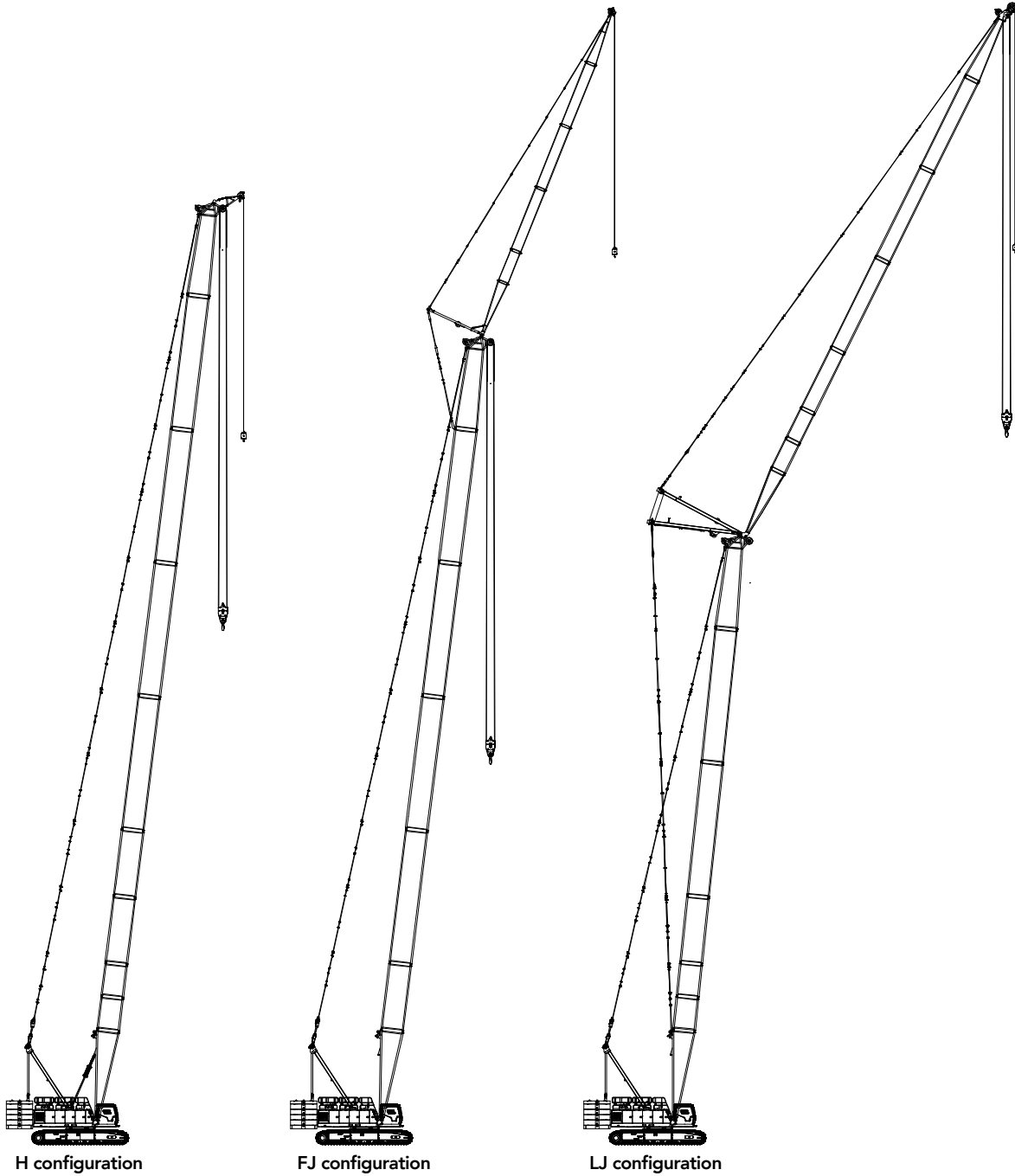

H Configuration

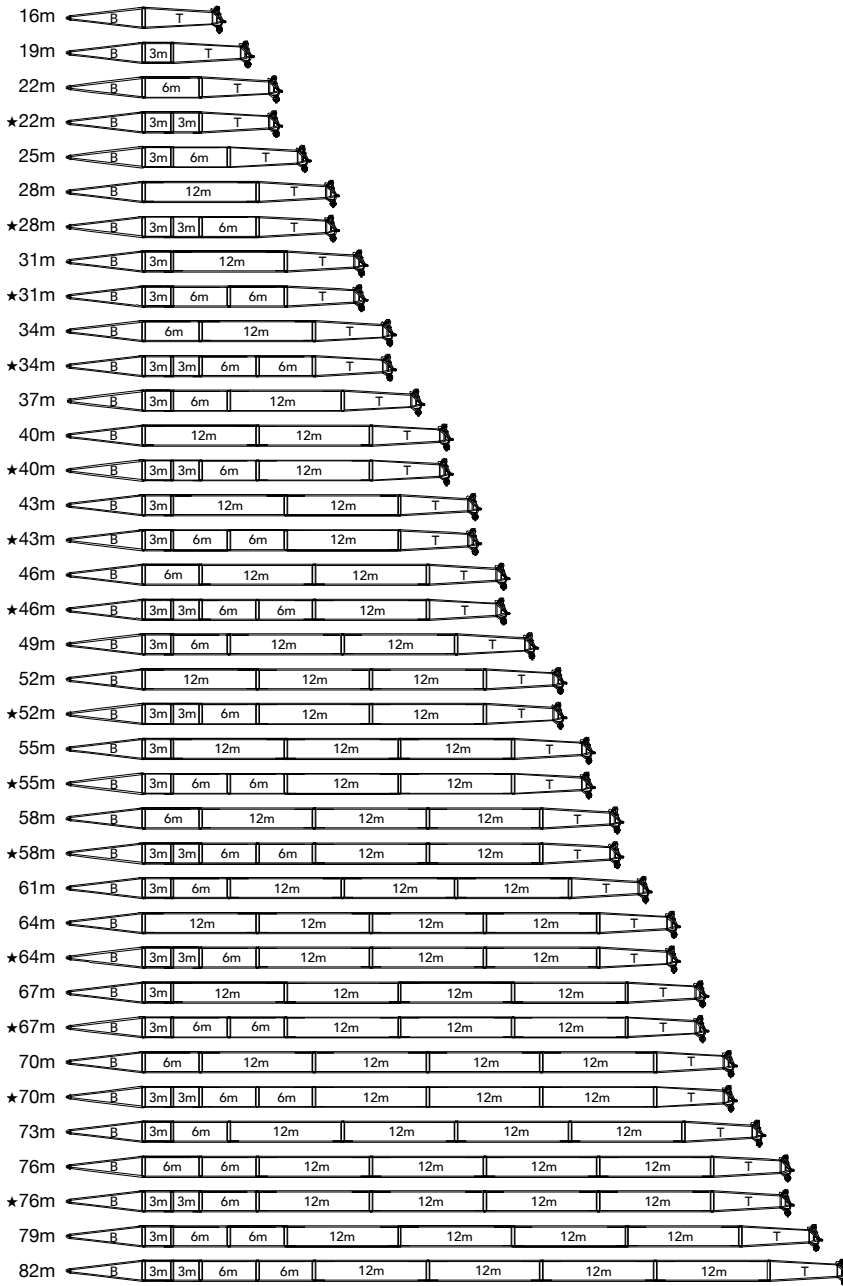

Note: ★ means recommended boom combination.

	8m	Boom base
	8m	Boom top
	3m	Boom insert
	6m	Boom insert
	12m	Boom insert

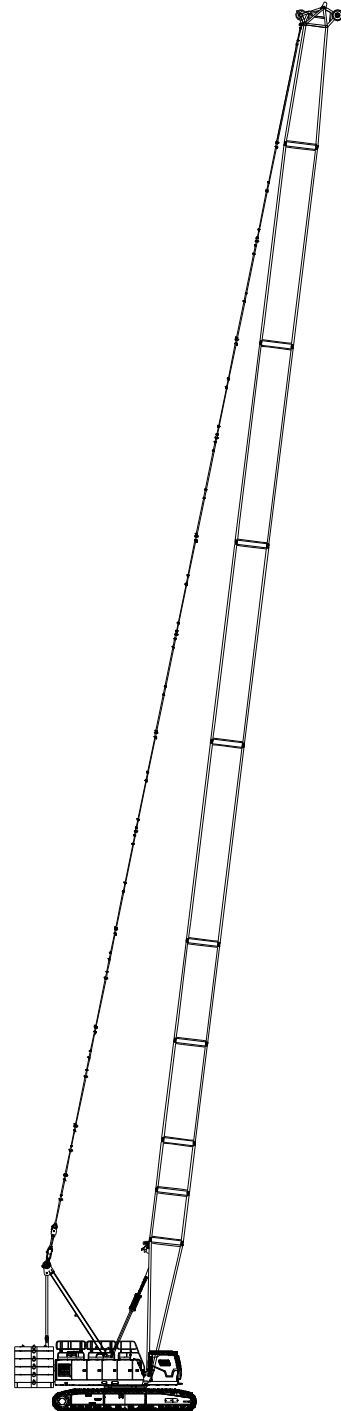

H configuration

H Working Radius

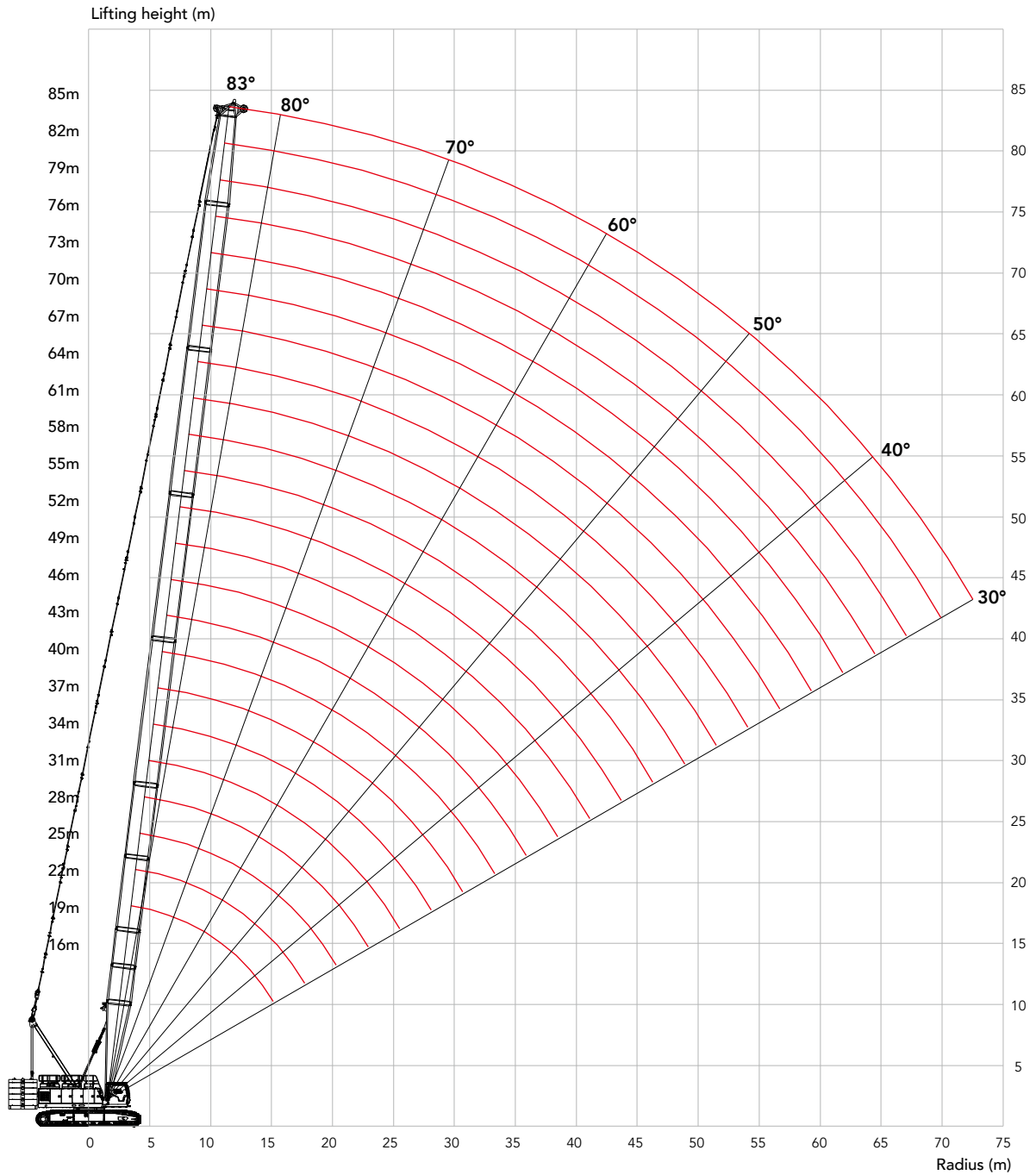

Unit: t

H Load Chart

Note:

- 1.The rated load in the load chart is calculated complying with EN 13000;
- 2.The working radius is the horizontal distance from the load center to the swing center;
- 3.The actual lifting capacity must subtract the weight of hooks and other riggings from the rated capacity in the load chart.
- 4.The load value is calculated when the object is hung freely,without considering the influence of wind on the load, ground conditions and slope, operation speed and the influence of any other negative factors over safe operation. Therefore, the operator bears the responsibility of making a judgement and decreasing the load and lowering speed.
- 5.All ratings are calculated when the machine is parking on firm and level ground with less than 1% gradient.

SCC1800A Crawler Crane – H Load Chart 1/2

Main Hook, Boom 16-82m, No extension jib													
Boom length/ radius (m)	16	19	22	25	28	31	34	37	40	43	46	49	Boom length/ radius (m)
5	180.0	171.0											5
6	166.0	158.8	149.1	138.9									6
7	150.0	145.9	141.9	136.1	132.7	123.9	114.4						7
8	132.0	130.9	130.0	128.8	127.9	122.8	115.2	106.6	98.8	92.2			8
9	114.0	114.0	114.0	111.0	110.1	108.1	105.7	103.3	97.8	91.1	81.0	80.6	9
10	97.0	96.9	96.8	96.7	95.3	94.6	93.3	91.3	89.4	87.2	80.2	78.6	10
12	74.5	74.5	74.5	74.5	74.5	74.5	73.1	72.4	72.3	71.1	69.9	68.6	12
14	59.9	59.9	59.9	59.9	59.9	59.9	59.9	59.8	58.6	58.1	58.0	57.7	14
16	50.2	50.0	50.0	50.0	50.0	50.0	50.0	50.0	49.9	49.2	48.4	48.2	16
18		42.1	42.4	42.2	42.1	41.9	41.8	41.7	42.5	42.3	42.3	41.4	18
20			37.1	37.1	37.1	37.0	37.0	37.0	36.8	36.7	36.6	36.5	20
22				32.6	32.6	32.5	32.5	32.5	32.3	32.2	32.1	32.0	22
24				30.0	29.0	28.9	28.9	28.8	28.7	28.5	28.5	28.3	24
26					26.1	25.9	25.9	25.8	25.7	25.5	25.5	25.3	26
28						23.5	23.5	23.3	23.2	23.0	23.0	22.8	28
30							21.4	21.2	21.0	20.8	20.8	20.6	30
32								19.4	19.3	19.1	19.0	18.8	32
34								17.3	17.7	17.5	17.4	17.2	34
36									16.4	16.2	16.1	15.8	36
38										15.0	14.8	14.6	38
40											13.8	13.6	40
42												12.6	42
44												11.7	44
46													46
48													48
50													50
52													52
54													54
56													56
58													58
60													60
62													62
64													64
66													66
68													68
70													70
72													72
Counter weight(t)	68+20	68+20	68+20	68+20	68+20	68+20	68+20	68+20	68+20	68+20	68+20	68+20	Counter weight(t)
Parts of line	16	14	12	11	10	10	9	8	8	7	6	6	Parts of line

H Load Chart**SCC1800A Crawler Crane – H Load Chart 2/2**

Main Hook, Boom 16-82m, No extension jib												
Boom length/ radius (m)	52	55	58	61	64	67	70	73	76	79	82	Boom length/ radius (m)
5												5
6												6
7												7
8												8
9	74.9											9
10	73.1	67.4	64.2	61.1								10
12	67.4	63.3	62.3	58.7	53.9	50.7	46.5	42.5	39.2	36.1		12
14	56.7	55.7	54.8	53.9	51.1	49.6	45.1	41.3	38.6	35.9	32.8	14
16	48.0	47.9	47.1	46.3	45.6	44.8	42.6	40.1	37.1	35.0	31.9	16
18	40.9	40.7	40.6	40.4	39.8	39.1	38.5	37.5	35.5	33.9	30.9	18
20	36.0	35.3	35.1	35.0	34.8	34.5	34.0	33.4	32.8	32.1	29.9	20
22	31.8	31.5	31.0	30.6	30.5	30.3	30.1	29.7	29.2	28.7	28.1	22
24	28.2	28.0	27.9	27.3	27.0	26.8	26.6	26.4	26.2	25.7	25.1	24
26	25.1	24.9	24.9	24.7	24.2	23.9	23.8	23.6	23.4	23.1	22.6	26
28	22.6	22.4	22.3	22.1	21.9	21.5	21.3	21.1	20.9	20.7	20.4	28
30	20.4	20.2	20.2	20.0	19.8	19.5	19.3	19.0	18.9	18.7	18.4	30
32	18.6	18.4	18.3	18.1	17.9	17.7	17.5	17.3	17.1	16.9	16.6	32
34	17.0	16.8	16.7	16.5	16.3	16.1	15.9	15.7	15.5	15.3	15.1	34
36	15.7	15.4	15.3	15.1	14.9	14.7	14.5	14.3	14.1	13.9	13.7	36
38	14.5	14.2	14.1	13.9	13.7	13.5	13.3	13.1	12.9	12.7	12.5	38
40	13.4	13.2	13.0	12.8	12.6	12.4	12.3	12.0	11.8	11.6	11.4	40
42	12.4	12.2	12.1	11.8	11.7	11.4	11.3	11.1	10.9	10.7	10.4	42
44	11.5	11.3	11.2	11.0	10.8	10.6	10.4	10.2	10.0	9.8	9.6	44
46	10.7	10.5	10.4	10.2	10.0	9.8	9.6	9.4	9.2	9.0	8.8	46
48		9.8	9.7	9.4	9.3	9.0	8.9	8.7	8.5	8.3	8.0	48
50			9.0	8.8	8.6	8.4	8.2	8.0	7.8	7.6	7.4	50
52			8.4	8.2	8.0	7.8	7.6	7.4	7.2	7.0	6.7	52
54				7.6	7.4	7.2	7.1	6.8	6.6	6.4	6.2	54
56					6.9	6.7	6.5	6.3	6.1	5.9	5.7	56
58						6.2	6.0	5.8	5.6	5.4	5.2	58
60						5.7	5.6	5.4	5.2	4.9	4.7	60
62							5.2	4.9	4.8	4.5	4.2	62
64								4.6	4.4	4.1	3.8	64
66									4.0	3.7	3.4	66
68										3.4	3.0	68
70										3.0	2.6	70
72											2.3	72
Counter weight(t)	68+20	68+20	68+20	68+20	68+20	68+20	68+20	68+20	68+20	68+20	68+20	Counter weight(t)
Parts of line	6	5	5	5	4	4	4	4	3	3	3	Parts of line

FJ Configuration

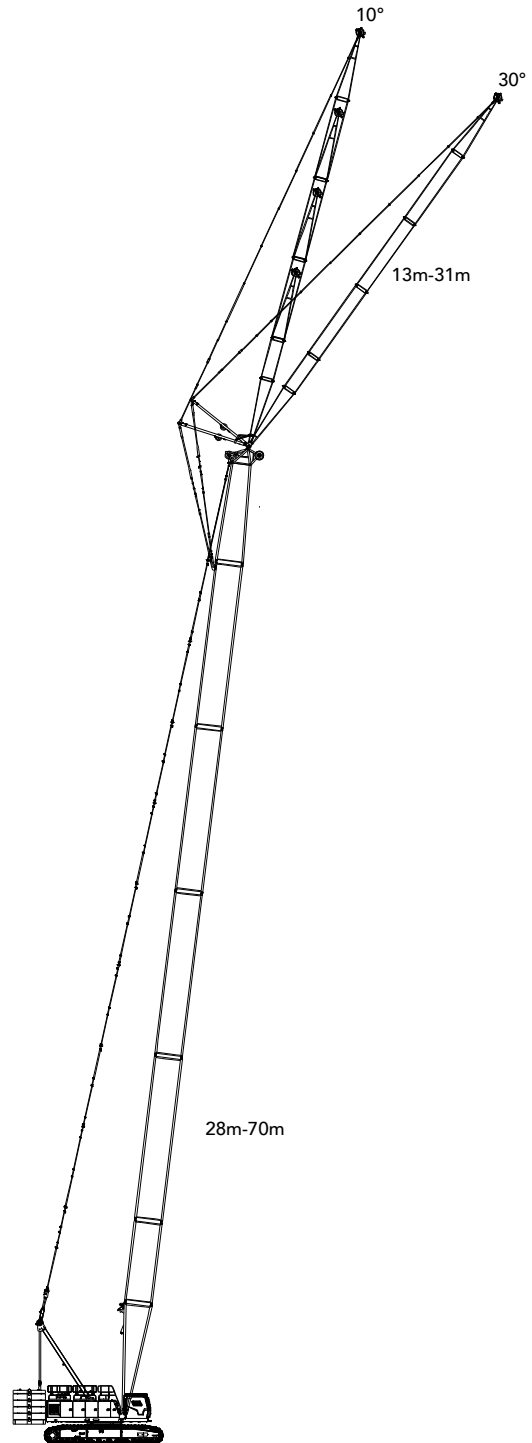
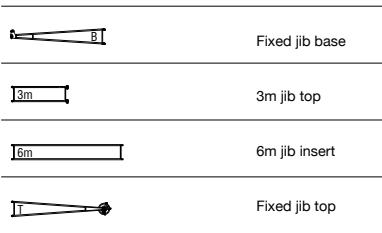
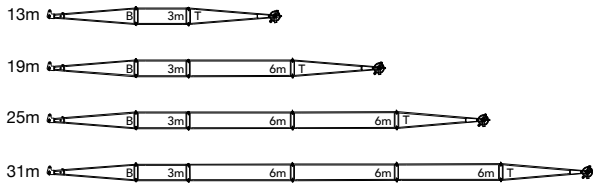

FJ Working Radius

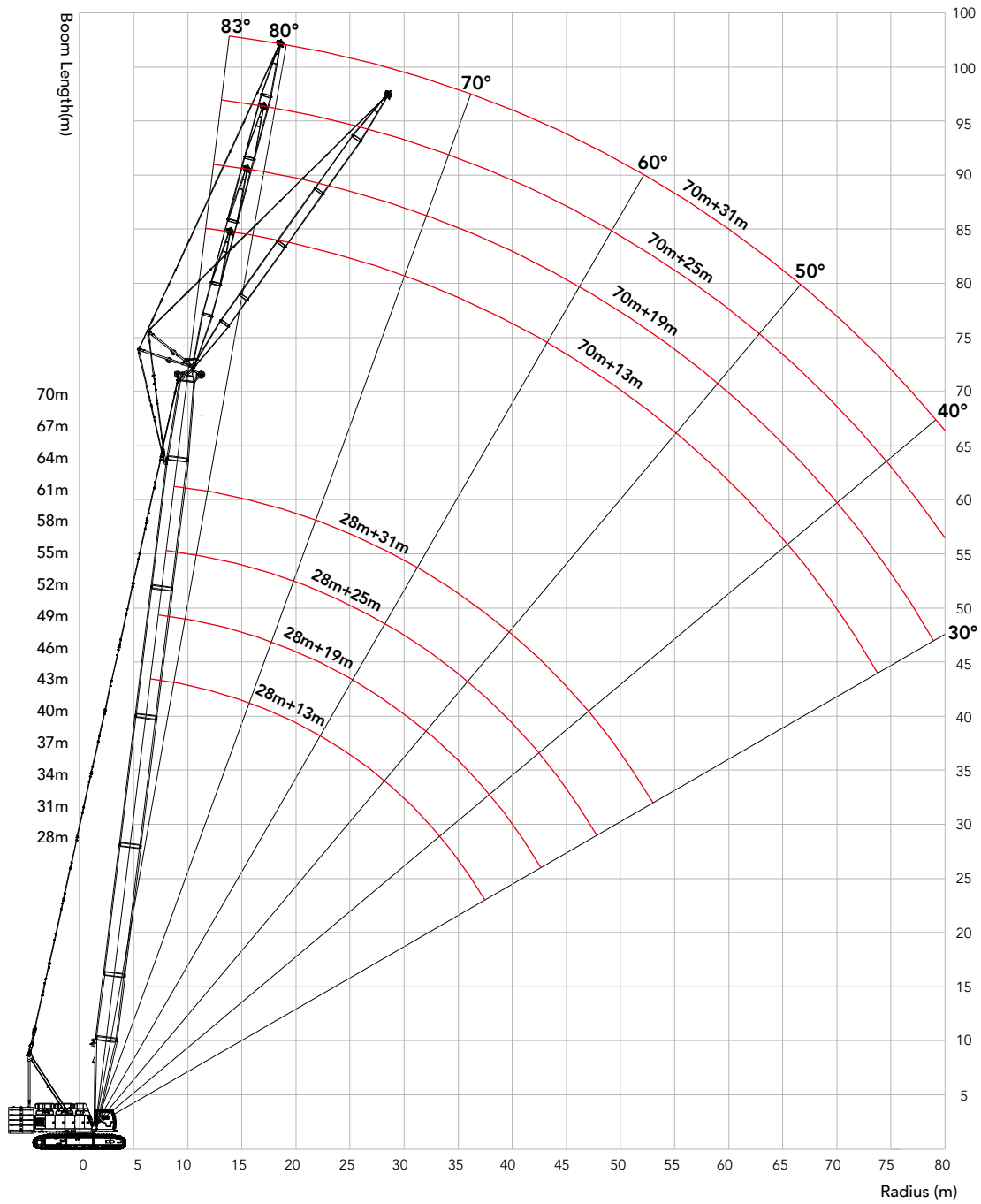

Unit: t

FJ Load Chart

Note:

- 1.The rated load in the load chart is calculated complying with EN 13000;
- 2.The working radius is the horizontal distance from the load center to the swing center;
- 3.The actual lifting capacity must subtract the weight of hooks and other riggings from the rated capacity in the load chart.
- 4.The load value is calculated when the object is hung freely,without considering the influence of wind on the load, ground conditions and slope, operation speed and the influence of any other negative factors over safe operation. Therefore, the operator bears the responsibility of making a judgement and decreasing the load and lowering speed.
- 5.All ratings are calculated when the machine is parking on firm and level ground with less than 1% gradient.

SCC1800A Crawler Crane – FJa Load Chart 1/8																
Aux. hook, main boom 28-70m, jib 13m, boom to jib offset angle 10°																
Jib length (m) Radius (m)	28	31	34	37	40	43	46	49	52	55	58	61	64	67	70	Jib length (m) Radius (m)
10	34.0	33.4														10
12	32.3	32.3	32.1	31.9												12
14	31.6	31.5	31.5	31.5	31.6	31.3										14
16	30.7	30.9	31.0	30.9	30.5	30.2	29.9	29.7	29.5	29.2						16
18	30.0	30.1	30.3	30.0	29.6	29.3	29.0	28.8	28.6	28.3	28.1	27.9	27.7	27.5		18
20	29.3	29.5	29.6	29.2	28.8	28.5	28.2	27.9	27.6	27.5	27.3	27.0	26.4	25.9	25.3	20
22	28.8	28.9	28.2	27.9	27.7	27.4	27.1	26.8	26.5	26.3	26.1	25.6	25.0	24.5	23.8	22
24	28.0	27.3	26.7	26.4	26.1	25.8	25.6	25.3	25.1	24.9	24.6	24.3	23.6	23.0	22.3	24
26	26.2	25.8	25.3	25.0	24.7	24.5	24.3	24.1	23.9	23.6	23.1	22.6	22.0	21.5	20.8	26
28	24.3	24.1	24.0	23.8	23.6	23.4	23.2	23.1	22.4	21.9	21.6	21.1	20.5	20.0	19.3	28
30	22.3	22.1	21.9	21.7	21.6	21.4	21.2	21.0	20.9	20.2	20.0	19.8	19.3	18.7	18.0	30
32	20.5	20.3	20.2	19.9	19.8	19.6	19.4	19.2	19.1	18.9	18.7	18.5	18.0	17.5	16.9	32
34	18.9	18.7	18.6	18.4	18.2	18.0	17.9	17.7	17.5	17.3	17.1	16.9	16.8	16.2	15.6	34
36	17.6	17.4	17.2	17.0	16.9	16.6	16.5	16.3	16.1	15.9	15.8	15.6	15.4	15.0	14.5	36
38	16.4	16.2	16.0	15.8	15.6	15.4	15.3	15.1	14.9	14.7	14.5	14.3	14.2	14.0	13.6	38
40		15.1	15.0	14.7	14.6	14.3	14.2	14.0	13.8	13.6	13.5	13.3	13.1	12.9	12.7	40
42			14.0	13.8	13.6	13.4	13.2	13.0	12.8	12.6	12.5	12.3	12.1	11.9	11.7	42
44				12.9	12.7	12.5	12.4	12.1	12.0	11.7	11.6	11.4	11.2	11.0	10.8	44
46				12.1	11.9	11.7	11.6	11.3	11.2	10.9	10.8	10.6	10.4	10.2	10.0	46
48					11.2	11.0	10.8	10.6	10.4	10.2	10.1	9.9	9.7	9.5	9.3	48
50						10.3	10.2	9.9	9.8	9.5	9.4	9.2	9.0	8.8	8.6	50
52							9.5	9.3	9.1	8.9	8.8	8.6	8.4	8.1	7.9	52
54							9.0	8.8	8.6	8.4	8.2	8.0	7.8	7.5	7.3	54
56								8.2	8.1	7.8	7.7	7.4	7.2	6.9	6.8	56
58									7.6	7.3	7.1	6.9	6.7	6.4	6.2	58
60										6.8	6.7	6.4	6.2	5.9	5.7	60
62										6.4	6.2	6.0	5.7	5.5	5.3	62
64											5.8	5.5	5.3	5.1	4.9	64
66												5.1	4.9	4.7	4.5	66
68													4.5	4.3	4.1	68
70														3.9	3.7	70
72															3.6	72
74																74
Counter weight(t)	68+20	68+20	68+20	68+20	68+20	68+20	68+20	68+20	68+20	68+20	68+20	68+20	68+20	68+20	68+20	Counter weight(t)
Parts of line	3	3	3	3	3	3	3	3	3	3	3	3	3	3	2	Parts of line

FJ Load Chart

SCC1800A Crawler Crane – FJa Load Chart 2/8																
Aux. hook, main boom 28-70m, jib 19m, boom to jib offset angle 10°																
Jib length Radius (m)	28	31	34	37	40	43	46	49	52	55	58	61	64	67	70	Jib length Radius (m)
14	21.5	21.6														14
16	20.9	21.0	21.0	21.1	21.1	21.1										16
18	20.2	20.4	20.5	20.6	20.5	20.6	20.6	20.5	20.4	20.4						18
20	19.6	19.7	20.0	20.0	20.1	20.2	20.2	20.2	20.1	20.0	19.9	19.8	19.7	19.5		20
22	19.0	19.2	19.4	19.6	19.7	19.6	19.7	19.7	19.7	19.7	19.6	19.5	19.4	19.2	19.1	22
24	18.5	18.7	18.9	19.1	19.1	19.3	19.3	19.4	19.4	19.3	19.3	19.2	19.2	19.0	18.8	24
26	18.0	18.3	18.5	18.6	18.7	18.9	18.9	19.1	19.0	19.0	19.0	18.9	18.8	18.7	18.6	26
28	17.6	17.9	18.0	18.2	18.3	18.5	18.6	18.6	18.7	18.6	18.6	18.6	18.5	18.5	18.3	28
30	17.2	17.4	17.7	17.8	18.0	18.1	18.2	18.3	18.3	18.3	18.4	18.3	18.3	18.2	18.0	30
32	16.4	16.5	16.7	16.8	16.9	17.0	17.1	17.2	17.3	17.4	17.5	17.6	17.7	17.5	17.2	32
34	15.6	15.7	15.9	16.0	16.1	16.2	16.3	16.4	16.5	16.6	16.7	16.8	16.7	16.3	15.9	34
36	14.9	15.0	15.2	15.3	15.4	15.5	15.6	15.7	15.8	15.9	16.0	15.9	15.6	15.2	14.8	36
38	14.1	14.2	14.4	14.5	14.6	14.7	14.8	14.9	15.0	15.0	14.8	14.6	14.5	14.1	13.8	38
40	13.6	13.7	13.8	13.9	14.0	14.1	14.2	14.3	14.1	13.9	13.7	13.5	13.4	13.2	12.9	40
42	12.9	13.0	13.1	13.2	13.3	13.4	13.5	13.3	13.1	12.9	12.8	12.6	12.4	12.2	12.0	42
44	12.2	12.3	12.5	12.6	12.7	12.7	12.6	12.4	12.2	12.0	11.9	11.7	11.5	11.3	11.1	44
46		11.8	12.0	12.1	12.2	11.9	11.8	11.6	11.4	11.2	11.1	10.9	10.7	10.5	10.3	46
48			11.5	11.6	11.4	11.2	11.1	10.9	10.7	10.5	10.3	10.1	9.9	9.7	9.6	48
50				10.9	10.8	10.5	10.4	10.2	10.0	9.8	9.7	9.5	9.3	9.1	8.9	50
52				10.3	10.1	9.9	9.8	9.6	9.4	9.2	9.0	8.8	8.6	8.4	8.3	52
54					9.6	9.4	9.2	9.0	8.8	8.6	8.5	8.3	8.1	7.8	7.6	54
56						8.8	8.7	8.5	8.3	8.1	7.9	7.7	7.5	7.3	7.1	56
58							8.2	8.0	7.8	7.6	7.4	7.2	7.0	6.7	6.5	58
60								7.5	7.4	7.1	7.0	6.7	6.5	6.2	6.1	60
62								7.1	6.9	6.7	6.5	6.2	6.0	5.8	5.6	62
64									6.5	6.2	6.1	5.8	5.6	5.4	5.2	64
66										5.8	5.7	5.4	5.2	5.0	4.8	66
68											5.3	5.0	4.8	4.6	4.4	68
70											4.9	4.7	4.5	4.2	4.0	70
72												4.3	4.1	3.9	3.7	72
74													3.8	3.6	3.4	74
76														3.3	3.1	76
78														3.0	2.8	78
80															2.5	80
Counter weight(t)	68+20	68+20	68+20	68+20	68+20	68+20	68+20	68+20	68+20	68+20	68+20	68+20	68+20	68+20	68+20	Counter weight(t)
Parts of line	2	2	2	2	2	2	2	2	2	2	2	2	2	2	2	Parts of line

Unit: t

FJ Load Chart

SCC1800A Crawler Crane – FJa Load Chart 3/8																
Aux. hook, main boom 28-70m, jib 25m, boom to jib offset angle 10°																
Jib length (m) Radius (m)	28	31	34	37	40	43	46	49	52	55	58	61	64	67	70	Jib length (m) Radius (m)
16	15.8	15.8														16
18	15.3	15.4	15.4	15.4	15.3	15.3										18
20	14.9	14.9	14.9	15.0	14.9	14.9	14.9	14.8	14.8	14.7						20
22	14.4	14.5	14.5	14.5	14.5	14.5	14.5	14.5	14.4	14.4	14.3	14.1	14.0	13.8		22
24	14.0	14.0	14.1	14.1	14.2	14.2	14.2	14.2	14.1	14.1	14.0	13.9	13.8	13.6	13.4	24
26	13.5	13.6	13.7	13.8	13.8	13.8	13.8	13.8	13.8	13.8	13.7	13.6	13.5	13.4	13.2	26
28	13.1	13.2	13.3	13.4	13.4	13.5	13.5	13.5	13.5	13.5	13.4	13.3	13.3	13.1	12.9	28
30	12.8	12.8	12.9	13.0	13.1	13.1	13.1	13.2	13.2	13.2	13.1	13.1	13.0	12.9	12.7	30
32	12.4	12.5	12.6	12.7	12.7	12.7	12.7	12.8	12.9	12.9	12.8	12.8	12.7	12.6	12.5	32
34	12.1	12.2	12.2	12.3	12.3	12.3	12.4	12.5	12.6	12.6	12.5	12.6	12.5	12.3	12.2	34
36	11.6	11.7	11.8	11.9	11.9	12.0	12.0	12.1	12.2	12.3	12.3	12.3	12.2	12.0	11.9	36
38	11.2	11.3	11.4	11.5	11.6	11.5	11.6	11.7	11.8	11.9	11.9	11.8	11.7	11.6	11.5	38
40	10.7	10.8	10.9	11.0	11.1	11.1	11.2	11.3	11.4	11.5	11.6	11.5	11.4	11.3	11.2	40
42	10.2	10.3	10.4	10.5	10.6	10.7	10.8	10.9	11.0	11.1	11.2	11.1	11.0	10.9	10.8	42
44	9.8	9.9	10.0	10.1	10.2	10.3	10.4	10.5	10.6	10.7	10.8	10.7	10.6	10.5	10.4	44
46	9.4	9.5	9.6	9.7	9.8	9.9	10.0	10.1	10.2	10.3	10.4	10.3	10.2	10.1	10.0	46
48	9.0	9.1	9.2	9.3	9.4	9.5	9.6	9.7	9.8	9.9	10.0	9.9	9.8	9.7	9.6	48
50		8.8	8.9	9.0	9.1	9.2	9.3	9.4	9.5	9.5	9.6	9.5	9.4	9.3	9.1	50
52		8.5	8.6	8.7	8.8	8.9	9.0	9.1	9.2	9.2	9.2	9.0	8.9	8.7	8.5	52
54			8.2	8.3	8.4	8.5	8.6	8.7	8.8	8.8	8.7	8.5	8.3	8.1	7.9	54
56				8.0	8.1	8.2	8.3	8.4	8.5	8.3	8.1	7.9	7.8	7.5	7.3	56
58					7.8	7.9	8.0	8.1	8.0	7.8	7.6	7.4	7.2	7.0	6.8	58
60					7.5	7.6	7.7	7.8	7.5	7.3	7.2	7.0	6.7	6.5	6.3	60
62						7.2	7.3	7.4	7.1	6.9	6.7	6.5	6.3	6.0	5.9	62
64							7.0	7.1	6.7	6.5	6.3	6.1	5.9	5.6	5.4	64
66								6.5	6.3	6.1	5.9	5.7	5.4	5.2	5.0	66
68								6.1	5.9	5.7	5.5	5.3	5.1	4.8	4.6	68
70									5.6	5.3	5.2	4.9	4.7	4.5	4.3	70
72										5.0	4.8	4.6	4.4	4.1	4.0	72
74											4.5	4.3	4.1	3.8	3.6	74
76												4.0	3.8	3.5	3.3	76
78												3.7	3.5	3.2	3.0	78
80													3.2	2.9	2.8	80
82														2.6	2.5	82
84															2.2	84
Counter weight(t)	68+20	68+20	68+20	68+20	68+20	68+20	68+20	68+20	68+20	68+20	68+20	68+20	68+20	68+20	68+20	Counter weight(t)
Parts of line	2	2	2	2	2	2	2	2	2	2	2	2	2	2	1	Parts of line

FJ Load Chart

SCC1800A Crawler Crane – FJa Load Chart 4/8																
Aux. hook, main boom 28-70m, jib 31m, boom to jib offset angle 10°																
Jib length Radius (m)	28	31	34	37	40	43	46	49	52	55	58	61	64	67	70	Jib length Radius (m)
18	9.8	9.8														18
20	9.5	9.5	9.5	9.6	9.6	9.6										20
22	9.2	9.2	9.2	9.3	9.3	9.3	9.3	9.3	9.3	9.3						22
24	8.9	8.9	9.0	9.0	9.1	9.1	9.1	9.1	9.1	9.1	9.1	9.0	9.0	8.9		24
26	8.6	8.7	8.7	8.8	8.8	8.8	8.9	8.9	8.9	8.9	8.9	8.8	8.8	8.8	8.7	26
28	8.4	8.4	8.5	8.5	8.6	8.6	8.6	8.7	8.7	8.7	8.7	8.7	8.6	8.6	8.5	28
30	8.1	8.2	8.2	8.3	8.3	8.4	8.4	8.5	8.5	8.5	8.5	8.5	8.5	8.4	8.4	30
32	7.8	8.0	8.0	8.1	8.1	8.2	8.2	8.2	8.3	8.3	8.3	8.3	8.3	8.3	8.2	32
34	7.6	7.7	7.7	7.8	7.9	8.0	8.0	8.1	8.1	8.1	8.1	8.1	8.1	8.1	8.1	34
36	7.3	7.5	7.5	7.6	7.7	7.7	7.8	7.9	7.9	7.9	7.9	8.0	7.9	7.9	7.9	36
38	7.0	7.2	7.3	7.3	7.4	7.4	7.5	7.7	7.7	7.7	7.7	7.8	7.8	7.8	7.8	38
40	6.8	7.0	7.1	7.1	7.2	7.3	7.4	7.5	7.5	7.6	7.6	7.6	7.6	7.6	7.6	40
42	6.6	6.7	6.8	6.9	7.0	7.1	7.2	7.3	7.4	7.4	7.4	7.5	7.5	7.5	7.5	42
44	6.3	6.5	6.6	6.7	6.8	6.9	7.0	7.1	7.2	7.3	7.3	7.3	7.3	7.3	7.3	44
46	6.2	6.3	6.4	6.5	6.6	6.7	6.8	6.9	7.0	7.1	7.1	7.2	7.2	7.2	7.1	46
48	6.0	6.1	6.2	6.3	6.4	6.5	6.6	6.7	6.8	6.9	7.0	7.0	7.1	7.1	7.0	48
50	5.8	5.9	6.0	6.1	6.2	6.3	6.4	6.5	6.6	6.7	6.8	6.9	6.9	6.9	6.8	50
52	5.6	5.7	5.8	5.9	6.0	6.1	6.2	6.3	6.4	6.5	6.6	6.7	6.8	6.8	6.7	52
54	5.4	5.5	5.6	5.7	5.8	5.9	6.0	6.1	6.2	6.3	6.4	6.5	6.6	6.7	6.5	54
56		5.3	5.4	5.5	5.6	5.7	5.8	5.9	6.0	6.1	6.2	6.3	6.4	6.5	6.3	56
58		5.1	5.2	5.3	5.4	5.5	5.6	5.7	5.8	5.9	6.0	6.1	6.2	6.3	6.1	58
60			4.9	5.0	5.1	5.2	5.3	5.4	5.5	5.6	5.7	5.8	5.9	6.0	5.9	60
62				4.7	4.8	4.9	5.0	5.1	5.2	5.3	5.4	5.5	5.6	5.7	5.6	62
64					4.5	4.6	4.7	4.8	4.9	5.0	5.1	5.2	5.3	5.4	5.3	64
66						4.3	4.4	4.5	4.6	4.7	4.8	4.9	5.0	5.1	5.0	66
68						4.0	4.1	4.2	4.3	4.4	4.5	4.6	4.7	4.8	4.7	68
70							3.8	3.9	4.0	4.1	4.2	4.3	4.4	4.5	4.4	70
72								3.6	3.7	3.8	3.9	4.0	4.1	4.2	4.1	72
74									3.4	3.5	3.6	3.7	3.8	3.9	3.8	74
76									3.1	3.2	3.3	3.4	3.5	3.6	3.5	76
78										2.9	3.0	3.1	3.2	3.3	3.2	78
80											2.7	2.8	2.9	3.0	3.0	80
82												2.5	2.6	2.7	2.7	82
84													2.2	2.3	2.4	84
86															2.2	86
Counter weight(t)	68+20	68+20	68+20	68+20	68+20	68+20	68+20	68+20	68+20	68+20	68+20	68+20	68+20	68+20	68+20	Counter weight(t)
Parts of line	1	1	1	1	1	1	1	1	1	1	1	1	1	1	1	Parts of line

Unit: t

FJ Load Chart

SCC1800A Crawler Crane – FJa Load Chart 5/8																
Aux. hook, main boom 28-70m, jib 13m, boom to jib offset angle 30°																
Jib length (m) Radius (m)	28	31	34	37	40	43	46	49	52	55	58	61	64	67	70	Jib length (m) Radius (m)
16	17.6	17.8														16
18	17.0	17.1	17.4	17.5	17.6	17.7										18
20	16.4	16.6	16.8	17.0	17.1	17.2	17.3	17.4	17.4	17.6						20
22	15.7	15.9	16.3	16.4	16.7	16.8	16.9	17.0	17.0	17.1	17.1	17.3	17.3	17.3		22
24	15.1	15.3	15.8	16.0	16.1	16.3	16.4	16.5	16.7	16.8	16.8	16.9	16.9	16.9	17.0	24
26	14.7	14.9	15.1	15.4	15.7	15.9	16.1	16.2	16.3	16.4	16.4	16.5	16.7	16.7	16.7	26
28	14.2	14.4	14.6	14.8	15.0	15.5	15.7	15.8	15.9	16.1	16.2	16.3	16.3	16.4	16.4	28
30	13.8	14.0	14.2	14.4	14.6	15.1	15.3	15.5	15.7	15.8	15.9	16.0	16.0	16.1	16.1	30
32	13.5	13.7	13.9	14.1	14.3	14.7	14.9	15.2	15.3	15.5	15.6	15.7	15.7	15.8	15.8	32
34	13.2	13.4	13.6	13.8	14.0	14.2	14.4	14.6	14.8	15.1	15.3	15.5	15.4	15.5	15.4	34
36	12.8	13.0	13.2	13.4	13.6	13.8	14.0	14.2	14.4	14.6	14.9	15.2	15.0	15.0	14.8	36
38	12.5	12.7	12.9	13.1	13.3	13.5	13.7	13.9	14.1	14.3	14.5	14.8	14.4	14.3	14.1	38
40		12.4	12.6	12.8	13.0	13.2	13.4	13.6	13.8	13.9	13.9	13.7	13.5	13.4	13.2	40
42		12.1	12.3	12.5	12.7	12.9	13.1	13.3	13.2	13.0	12.9	12.7	12.5	12.3	12.2	42
44			12.0	12.2	12.4	12.6	12.5	12.4	12.3	12.1	11.9	11.8	11.6	11.4	11.3	44
46				11.9	12.0	11.9	11.8	11.6	11.4	11.2	11.1	10.9	10.8	10.6	10.4	46
48					11.3	11.1	11.0	10.8	10.7	10.5	10.4	10.2	10.0	9.8	9.7	48
50						10.4	10.3	10.1	10.0	9.8	9.7	9.5	9.3	9.1	9.0	50
52						9.7	9.7	9.5	9.3	9.1	9.0	8.8	8.7	8.5	8.3	52
54							9.1	8.9	8.7	8.5	8.4	8.2	8.1	7.8	7.7	54
56								8.3	8.2	8.0	7.9	7.7	7.5	7.2	7.1	56
58									7.7	7.5	7.3	7.1	6.9	6.7	6.5	58
60									7.2	6.9	6.8	6.6	6.4	6.2	6.0	60
62										6.5	6.3	6.1	5.9	5.7	5.5	62
64											5.9	5.7	5.5	5.2	5.1	64
66												5.2	5.0	4.8	4.7	66
68												4.8	4.6	4.4	4.3	68
70													4.3	4.0	3.9	70
72														3.7	3.5	72
74															3.2	74
Counter weight(t) Parts of line	68+20	68+20	68+20	68+20	68+20	68+20	68+20	68+20	68+20	68+20	68+20	68+20	68+20	68+20	68+20	Counter weight(t) Parts of line
	2	2	2	2	2	2	2	2	2	2	2	2	2	2	2	

FJ Load Chart

SCC1800A Crawler Crane – FJa Load Chart 6/8																
Aux. hook, main boom 28-70m, jib 19m, boom to jib offset angle 30°																
Jib length (m) Radius (m)	28	31	34	37	40	43	46	49	52	55	58	61	64	67	70	Jib length (m) Radius (m)
20	12.1	12.3														20
22	11.7	11.8	12.0	12.1	12.2	12.2										22
24	11.3	11.4	11.6	11.7	11.8	11.9	12.0	12.0	12.1	12.1						24
26	10.8	11.1	11.2	11.3	11.5	11.5	11.7	11.7	11.8	11.8	11.9	11.9	12.0	12.1		26
28	10.4	10.7	10.8	11.0	11.1	11.2	11.4	11.4	11.6	11.6	11.7	11.7	11.8	11.8	11.8	28
30	10.0	10.3	10.4	10.7	10.8	10.9	11.1	11.2	11.3	11.3	11.4	11.5	11.6	11.6	11.6	30
32	9.6	9.8	10.0	10.4	10.6	10.7	10.8	10.9	11.0	11.1	11.2	11.2	11.3	11.4	11.4	32
34	9.4	9.5	9.6	10.1	10.3	10.4	10.6	10.7	10.7	10.9	10.9	11.0	11.1	11.2	11.2	34
36	9.1	9.2	9.3	9.7	10.0	10.2	10.4	10.5	10.5	10.7	10.7	10.9	10.9	11.0	11.0	36
38	8.9	9.0	9.1	9.4	9.7	10.0	10.1	10.3	10.4	10.4	10.6	10.7	10.7	10.8	10.9	38
40	8.6	8.7	8.8	9.2	9.4	9.7	9.9	10.0	10.2	10.2	10.4	10.4	10.6	10.6	10.6	40
42	8.3	8.4	8.5	8.8	9.2	9.5	9.7	9.9	10.0	10.1	10.2	10.3	10.3	10.4	10.3	42
44	8.2	8.3	8.4	8.7	9.0	9.3	9.6	9.7	9.9	9.9	10.0	10.1	10.2	10.2	10.1	44
46		8.2	8.3	8.6	8.9	9.1	9.4	9.6	9.7	9.8	9.9	9.9	9.9	10.0	9.9	46
48		8.1	8.2	8.5	8.8	9.0	9.2	9.4	9.5	9.6	9.8	9.8	9.8	9.8	9.7	48
50			8.1	8.4	8.7	8.9	9.0	9.1	9.4	9.4	9.5	9.6	9.6	9.5	9.4	50
52				8.3	8.6	8.8	8.8	9.0	9.2	9.2	9.2	9.2	9.1	8.9	8.8	52
54					8.5	8.7	8.7	8.9	8.9	8.9	8.8	8.6	8.5	8.3	8.2	54
56						8.6	8.5	8.7	8.5	8.4	8.3	8.1	7.9	7.7	7.6	56
58						8.4	8.3	8.2	8.0	7.9	7.7	7.6	7.4	7.2	7.0	58
60							7.8	7.7	7.5	7.4	7.2	7.0	6.9	6.7	6.5	60
62								7.2	7.1	6.9	6.8	6.6	6.4	6.2	6.0	62
64									6.6	6.4	6.3	6.1	5.9	5.7	5.5	64
66									6.2	6.0	5.9	5.7	5.5	5.3	5.1	66
68										5.6	5.5	5.2	5.1	4.9	4.7	68
70											5.1	4.9	4.7	4.5	4.3	70
72												4.5	4.3	4.1	4.0	72
74												4.1	4.0	3.8	3.6	74
76													3.6	3.4	3.3	76
78														3.1	3.0	78
80															2.6	80
Counter weight(t) Parts of line	68+20	68+20	68+20	68+20	68+20	68+20	68+20	68+20	68+20	68+20	68+20	68+20	68+20	68+20	74+25	Counter weight(t) Parts of line
	1	1	1	1	1	1	1	1	1	1	1	1	1	1	1	

Unit: t

FJ Load Chart

SCC1800A Crawler Crane – FJa Load Chart 7/8																
Aux. hook, main boom 28-70m, jib 25m, boom to jib offset angle 30°																
Jib length (m) Radius (m)	28	31	34	37	40	43	46	49	52	55	58	61	64	67	70	Jib length (m) Radius (m)
24	8.6	8.7														24
26	8.3	8.4	8.5	8.6	8.6	8.7										26
28	8.0	8.1	8.2	8.3	8.3	8.4	8.5	8.5	8.6	8.6						28
30	7.7	7.8	7.9	8.0	8.1	8.2	8.2	8.3	8.4	8.4	8.4	8.4	8.5	8.5		30
32	7.4	7.5	7.6	7.8	7.9	7.9	8.0	8.1	8.1	8.2	8.2	8.3	8.3	8.3	8.4	32
34	7.1	7.3	7.4	7.5	7.6	7.7	7.8	7.9	7.9	8.0	8.0	8.1	8.1	8.2	8.2	34
36	7.0	7.1	7.2	7.3	7.4	7.5	7.6	7.7	7.8	7.8	7.9	7.9	8.0	8.0	8.0	36
38	6.8	6.9	7.1	7.1	7.3	7.3	7.4	7.5	7.6	7.6	7.7	7.8	7.8	7.9	7.9	38
40	6.6	6.7	6.9	7.0	7.1	7.2	7.3	7.3	7.4	7.5	7.5	7.6	7.7	7.7	7.8	40
42	6.5	6.6	6.7	6.8	6.9	7.0	7.1	7.2	7.3	7.4	7.4	7.5	7.5	7.6	7.6	42
44	6.3	6.4	6.6	6.7	6.8	6.9	7.0	7.1	7.2	7.2	7.2	7.3	7.4	7.5	7.5	44
46	6.2	6.3	6.4	6.5	6.7	6.7	6.8	6.9	7.0	7.1	7.1	7.2	7.3	7.3	7.4	46
48	6.2	6.2	6.3	6.4	6.5	6.6	6.7	6.8	6.9	6.9	7.0	7.1	7.2	7.2	7.2	48
50	6.1	6.2	6.2	6.3	6.4	6.5	6.6	6.7	6.7	6.8	6.9	7.0	7.0	7.1	7.1	50
52		6.1	6.2	6.2	6.3	6.4	6.5	6.6	6.7	6.7	6.8	6.8	6.9	7.0	7.0	52
54		6.2	6.1	6.2	6.2	6.3	6.4	6.4	6.5	6.6	6.7	6.7	6.8	6.9	6.9	54
56			6.1	6.1	6.2	6.2	6.3	6.3	6.4	6.5	6.6	6.7	6.7	6.8	6.9	56
58				6.1	6.1	6.2	6.2	6.3	6.3	6.4	6.5	6.6	6.6	6.7	6.8	58
60					6.1	6.1	6.2	6.2	6.3	6.4	6.4	6.5	6.5	6.6	6.7	60
62						6.1	6.1	6.2	6.2	6.3	6.4	6.4	6.4	6.5	6.4	62
64							6.1	6.1	6.1	6.2	6.3	6.3	6.3	6.3	6.1	64
66								6.1	6.1	6.1	6.2	6.2	6.0	5.9	5.7	66
68									6.1	5.9	6.0	5.8	5.6	5.5	5.3	68
70										5.7	5.6	5.4	5.2	5.1	4.9	70
72											5.4	5.2	5.1	4.9	4.7	72
74												4.8	4.7	4.5	4.3	74
76													4.3	4.2	4.0	76
78														3.8	3.7	78
80															3.5	80
82																82
84																84
Counter weight(t)	68+20	68+20	68+20	68+20	68+20	68+20	68+20	68+20	68+20	68+20	68+20	68+20	68+20	68+20	68+20	Counter weight(t)
Parts of line	1	1	1	1	1	1	1	1	1	1	1	1	1	1	1	Parts of line

FJ Load Chart

SCC1800A Crawler Crane – FJa Load Chart 8/8																
Aux. hook, main boom 28-70m, jib 31m, boom to jib offset angle 30°																
Jib length Radius (m)	28	31	34	37	40	43	46	49	52	55	58	61	64	67	70	Jib length Radius (m)
28	6.2	6.3														28
30	6.0	6.1	6.2	6.2	6.2	6.3										30
32	5.8	5.8	5.9	6.0	6.0	6.1	6.2	6.2	6.2	6.2						32
34	5.6	5.7	5.7	5.8	5.9	5.9	5.9	6.0	6.0	6.1	6.1	6.2	6.2	6.2		34
36	5.4	5.4	5.5	5.6	5.7	5.7	5.8	5.8	5.9	5.9	6.0	6.0	6.1	6.1	6.1	36
38	5.2	5.3	5.4	5.4	5.5	5.6	5.6	5.7	5.8	5.8	5.9	5.9	5.9	6.0	6.0	38
40	5.0	5.1	5.2	5.3	5.4	5.4	5.5	5.6	5.6	5.7	5.7	5.7	5.8	5.8	5.9	40
42	4.8	5.0	5.1	5.2	5.2	5.3	5.4	5.4	5.5	5.6	5.6	5.6	5.7	5.7	5.7	42
44	4.7	4.8	4.9	5.0	5.1	5.2	5.2	5.3	5.3	5.4	5.4	5.5	5.5	5.6	5.6	44
46	4.6	4.7	4.8	4.9	4.9	5.0	5.1	5.2	5.2	5.3	5.3	5.4	5.4	5.4	5.5	46
48	4.5	4.6	4.7	4.8	4.8	4.9	5.0	5.0	5.1	5.2	5.2	5.3	5.3	5.4	5.4	48
50	4.4	4.5	4.6	4.7	4.7	4.8	4.9	4.9	5.0	5.1	5.1	5.2	5.2	5.3	5.3	50
52	4.3	4.4	4.5	4.6	4.6	4.7	4.8	4.9	4.9	5.0	5.0	5.1	5.1	5.2	5.2	52
54	4.2	4.3	4.4	4.5	4.6	4.6	4.7	4.8	4.8	4.9	4.9	5.0	5.0	5.1	5.1	54
56	4.2	4.2	4.4	4.4	4.5	4.5	4.6	4.7	4.8	4.8	4.9	4.9	5.0	5.0	5.0	56
58		4.2	4.2	4.4	4.4	4.4	4.5	4.6	4.6	4.7	4.8	4.8	4.9	4.9	4.9	58
60		4.3	4.2	4.3	4.4	4.4	4.4	4.5	4.6	4.6	4.7	4.7	4.8	4.8	4.9	60
62			4.3	4.2	4.3	4.4	4.4	4.4	4.5	4.5	4.6	4.7	4.7	4.8	4.8	62
64				4.3	4.2	4.3	4.4	4.4	4.4	4.5	4.5	4.6	4.6	4.7	4.8	64
66					4.2	4.2	4.3	4.4	4.4	4.4	4.5	4.5	4.6	4.6	4.7	66
68						4.2	4.2	4.3	4.3	4.4	4.4	4.5	4.5	4.6	4.6	68
70						4.3	4.2	4.2	4.3	4.3	4.4	4.4	4.5	4.5	4.6	70
72							4.3	4.2	4.2	4.3	4.3	4.3	4.4	4.4	4.5	72
74								4.3	4.2	4.2	4.3	4.2	4.3	4.3	4.3	74
76									4.2	4.2	4.2	4.1	4.2	4.1	4.0	76
78									4.3	4.2	4.2	4.0	4.0	3.8	3.7	78
80										4.1	4.0	3.8	3.7	3.5	3.3	80
82												3.5	3.4	3.2	3.0	82
84												3.2	3.1	2.9	2.8	84
86													2.8	2.6	2.5	86
88													2.5	2.4	2.2	88
Counter weight(t)	68+20	68+20	68+20	68+20	68+20	68+20	68+20	68+20	68+20	68+20	68+20	68+20	68+20	68+20	68+20	Counter weight(t)
Parts of line	1	1	1	1	1	1	1	1	1	1	1	1	1	1	1	Parts of line

LJ Configuration

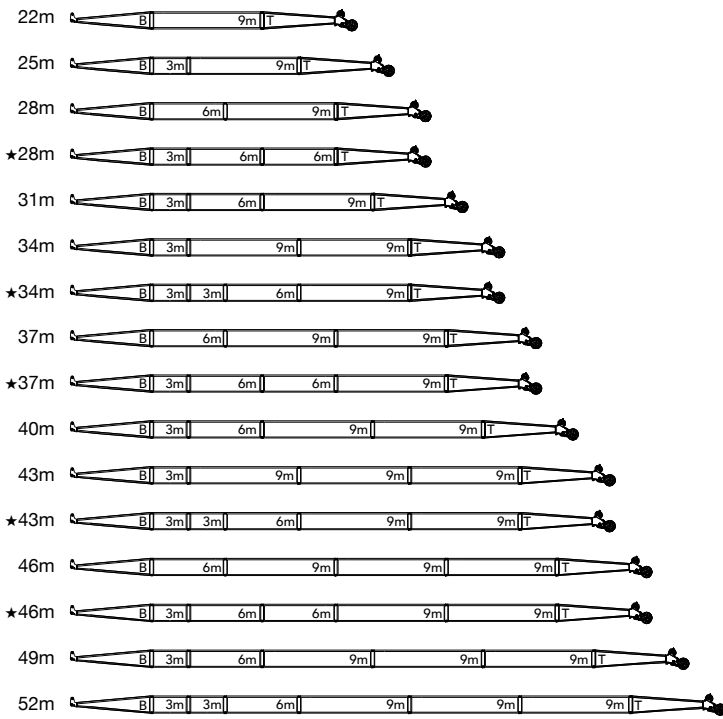

Note: ★ means recommended jib combination.

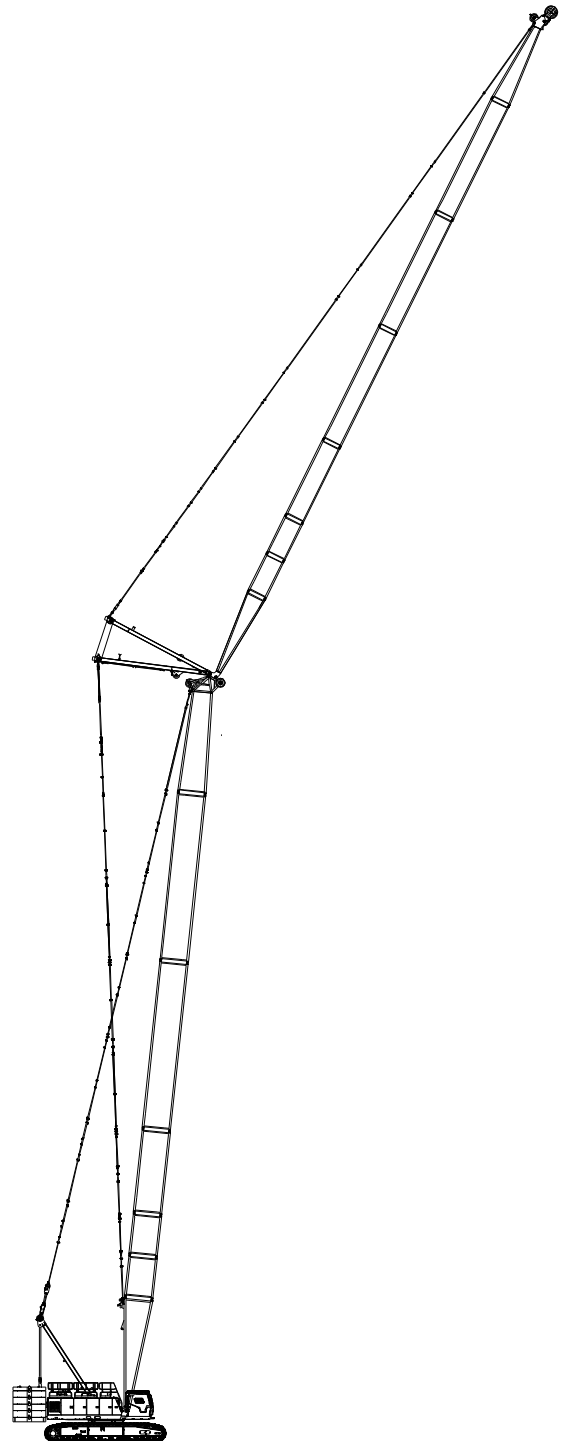
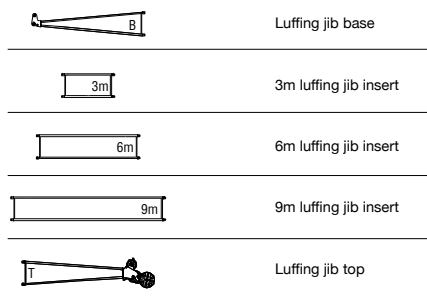

LJ Working Radius

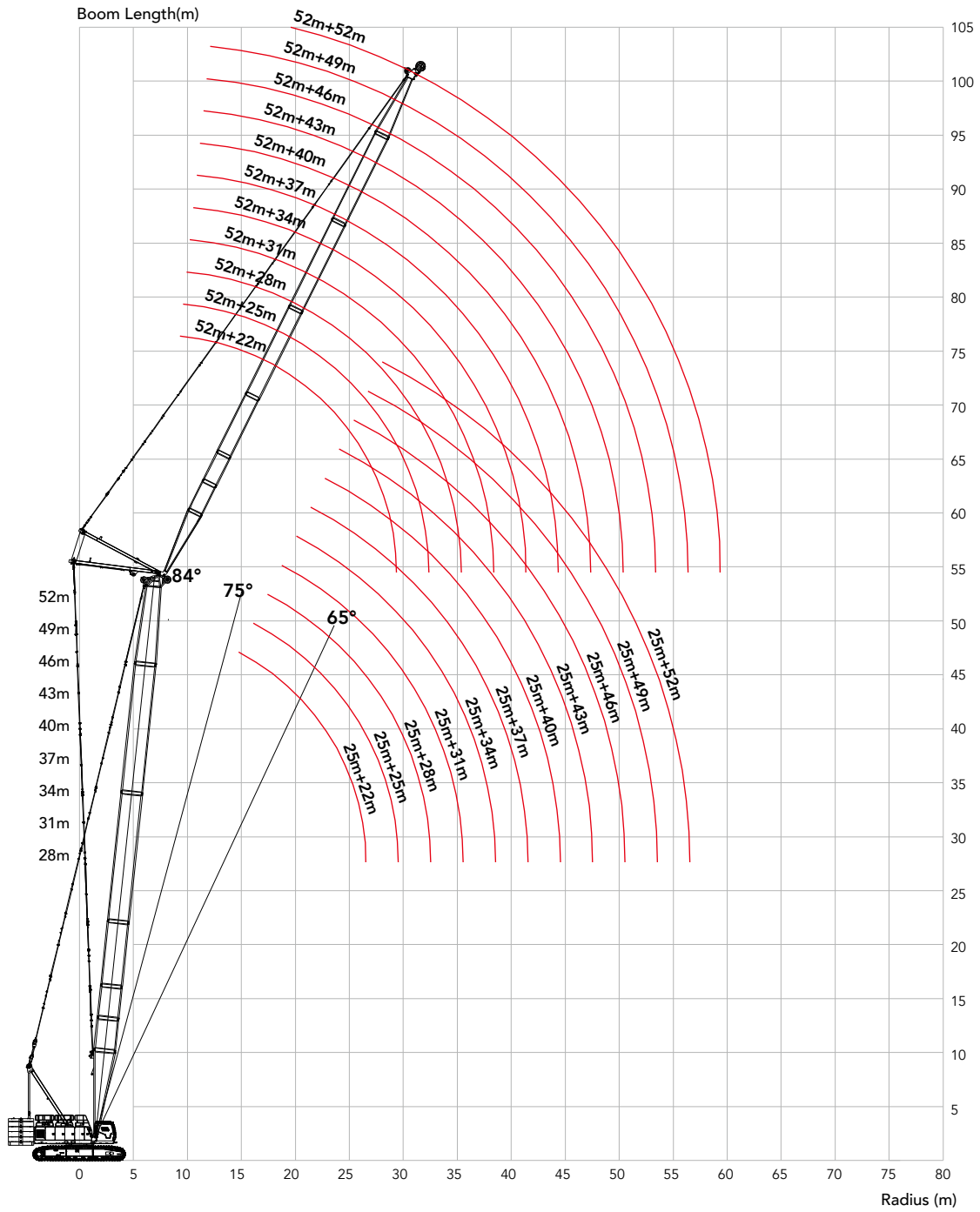

Unit: t

LJ Load Chart

Note:

- 1.The rated load in the load chart is calculated complying with EN 13000;
- 2.The working radius is the horizontal distance from the load center to the swing center;
- 3.The actual lifting capacity must subtract the weight of hooks and other riggings from the rated capacity in the load chart.
- 4.The load value is calculated when the object is hung freely,without considering the influence of wind on the load, ground conditions and slope, operation speed and the influence of any other negative factors over safe operation. Therefore, the operator bears the responsibility of making a judgement and decreasing the load and lowering speed.
- 5.All ratings are calculated when the machine is parking on firm and level ground with less than 1% gradient.

SCC1800A Crawler Crane -- LJ Load Chart 1/10												
Aux. hook, boom 25m, boom angle 84°												
Jib length (m) Radius (m)	22	25	28	31	34	37	40	43	46	49	52	Jib length (m) Radius (m)
12	61.3	59.6										12
14	52.7	52.2	51.0	49.9								14
16	43.1	43.4	44.5	44.4	43.6	37.7	33.0					16
18	36.4	36.6	37.6	37.4	37.3	37.2	32.7	28.5	25.0			18
20	31.4	31.6	32.5	32.3	32.2	32.1	31.9	28.2	24.7	21.7	19.2	20
22	27.6	27.7	28.5	28.4	28.3	28.1	27.9	27.8	24.3	21.4	18.8	22
24	24.5	24.7	25.4	25.2	25.1	25.0	24.8	24.7	23.9	21.0	18.4	24
26		22.2	22.8	22.7	22.6	22.4	22.3	22.1	22.0	20.7	18.1	26
28		18.3	20.7	20.6	20.5	20.3	20.2	20.0	19.9	19.7	17.7	28
30			17.9	18.8	18.7	18.5	18.4	18.2	18.1	18.0	17.4	30
32				17.2	17.1	17.0	16.8	16.7	16.6	16.4	16.3	32
34				13.3	15.8	15.7	15.5	15.4	15.3	15.1	15.0	34
36					13.0	14.5	14.4	14.3	14.1	14.0	13.8	36
38						12.6	13.4	13.3	13.1	13.0	12.8	38
40						9.9	12.1	12.4	12.2	12.1	11.9	40
42							9.9	11.5	11.4	11.3	11.1	42
44								9.5	10.7	10.5	10.4	44
46								7.5	9.1	9.9	9.8	46
48									7.4	8.8	9.2	48
50										7.3	8.4	50
52											6.9	52
54											5.6	54
Counter weight(t)	68+20											Counter weight(t)
Parts of line	5	5	4	4	4	3	3	3	2	2	2	Parts of line

LJ Load Chart

SCC1800A Crawler Crane -- LJ Load Chart 2/10												
Aux. hook, boom 28m, boom angle 84°												
Jib length (m) Radius (m)	22	25	28	31	34	37	40	43	46	49	52	Jib length (m) Radius (m)
12	58.8											12
14	51.1	50.4	49.6	48.4								14
16	44.4	44.6	44.0	43.3	42.0	36.5						16
18	37.3	37.5	38.6	38.6	38.2	36.3	31.8	27.8	24.4			18
20	32.1	32.3	33.2	33.2	33.2	33.1	31.5	27.5	24.1	21.3	18.8	20
22	28.1	28.3	29.1	29.0	29.0	28.9	28.8	27.2	23.8	21.0	18.5	22
24	25.0	25.1	25.8	25.7	25.7	25.6	25.5	25.4	23.5	20.7	18.1	24
26	20.3	22.5	23.2	23.1	23.1	23.0	22.8	22.7	22.6	20.3	17.8	26
28		20.3	21.0	20.9	20.9	20.8	20.7	20.5	20.4	20.0	17.5	28
30			19.1	19.1	19.0	18.9	18.8	18.7	18.5	18.4	17.1	30
32				17.5	17.4	17.3	17.2	17.1	17.0	16.8	16.7	32
34				14.6	16.1	16.0	15.9	15.8	15.6	15.5	15.3	34
36					14.3	14.8	14.7	14.6	14.4	14.3	14.2	36
38						13.7	13.6	13.5	13.4	13.2	13.1	38
40						11.0	12.7	12.6	12.5	12.3	12.2	40
42							10.9	11.8	11.6	11.5	11.4	42
44								10.5	10.9	10.8	10.6	44
46								8.4	10.1	10.1	10.0	46
48									8.3	9.5	9.4	48
50										8.1	8.8	50
52										6.4	7.8	52
54											6.3	54
Counter weight(t) Parts of line	68+20											Counter weight(t) Parts of line
	5	4	4	4	4	3	3	3	2	2	2	

Unit: t

LJ Load Chart

SCC1800A Crawler Crane -- LJ Load Chart 3/10												
Aux. hook, boom 31m, boom angle 84°												
Jib length (m) Radius (m)	22	25	28	31	34	37	40	43	46	49	52	Jib length (m) Radius (m)
12	56.7											12
14	49.7	48.9	48.0	46.5								14
16	43.9	43.2	42.6	42.1	40.4	35.3						16
18	38.3	38.5	38.3	37.9	37.2	35.1	30.8	27.0				18
20	32.8	33.0	34.0	33.9	33.7	33.2	30.5	26.8	23.6	20.8	18.4	20
22	28.7	28.8	29.7	29.6	29.6	29.5	29.4	26.5	23.3	20.5	18.1	22
24	25.4	25.5	26.3	26.2	26.2	26.1	26.0	25.9	23.0	20.2	17.8	24
26	22.6	22.9	23.6	23.5	23.4	23.4	23.2	23.2	22.7	19.9	17.5	26
28		20.7	21.3	21.2	21.2	21.1	21.0	20.9	20.8	19.6	17.2	28
30			19.4	19.3	19.3	19.2	19.1	19.0	18.9	18.7	16.9	30
32			16.0	17.7	17.7	17.6	17.4	17.4	17.3	17.1	16.6	32
34				15.9	16.3	16.2	16.1	16.0	15.9	15.7	15.6	34
36					15.1	15.0	14.8	14.7	14.6	14.5	14.4	36
38						11.9	13.9	13.8	13.7	13.6	13.4	38
40							12.0	12.8	12.7	12.6	12.5	40
42								11.8	11.9	11.8	11.6	42
44									11.1	11.0	10.9	44
46									9.2	10.3	10.2	46
48										9.0	9.6	48
50											8.8	50
52											7.0	52
54											7.0	54
Counter weight(t)	68+20											Counter weight(t)
Parts of line	5	4	4	4	3	3	3	2	2	2	2	Parts of line

LJ Load Chart

SCC1800A Crawler Crane -- LJ Load Chart 4/10												
Aux. hook, boom 34m, boom angle 84°												
Jib length (m) Radius (m)	22	25	28	31	34	37	40	43	46	49	52	Jib length (m) Radius (m)
12	55.1											12
14	48.5	47.6	46.6									14
16	42.9	42.1	41.4	40.8	38.7	33.9						16
18	38.1	37.6	37.2	36.8	36.2	33.7	29.7	26.2				18
20	33.6	33.8	33.7	33.3	32.8	32.3	29.5	25.9	22.9	20.3		20
22	29.3	29.4	30.3	30.2	30.0	29.4	29.1	25.7	22.7	20.0	17.7	22
24	25.9	26.0	26.8	26.7	26.7	26.6	26.5	25.4	22.4	19.8	17.4	24
26	23.2	23.3	23.9	23.9	23.8	23.8	23.6	23.6	22.1	19.5	17.1	26
28		21.0	21.6	21.5	21.5	21.4	21.3	21.2	21.1	19.2	16.8	28
30			19.7	19.6	19.5	19.5	19.3	19.3	19.2	18.9	16.6	30
32			17.4	17.9	17.9	17.8	17.7	17.6	17.5	17.4	16.3	32
34				16.5	16.5	16.4	16.3	16.2	16.1	15.9	15.8	34
36					15.2	15.1	15.0	14.9	14.8	14.7	14.6	36
38					13.0	14.1	13.9	13.8	13.7	13.6	13.5	38
40						12.8	13.0	12.9	12.8	12.6	12.5	40
42							12.1	12.0	11.9	11.8	11.7	42
44							9.9	11.3	11.1	11.0	10.9	44
46								9.9	10.4	10.3	10.2	46
48									9.7	9.7	9.6	48
50									7.6	9.1	9.0	50
52										7.6	8.5	52
54											7.4	54
Counter weight(t) Parts of line	68+20											Counter weight(t) Parts of line
	5	4	4	4	3	3	3	2	2	2	2	

Unit: t

LJ Load Chart

SCC1800A Crawler Crane -- LJ Load Chart 5/10												
Aux. hook, boom 37m, boom angle 84°												
Jib length (m) Radius (m)	22	25	28	31	34	37	40	43	46	49	52	Jib length (m) Radius (m)
14	46.8	46.1	45.0									14
16	41.5	41.2	40.4	39.4	36.9							16
18	37.0	36.9	36.3	35.8	35.1	32.3	28.6	25.3				18
20	33.3	33.1	32.9	32.5	31.9	31.3	28.4	25.1	22.2	19.7		20
22	29.9	30.0	29.9	29.5	29.2	28.7	28.2	24.9	22.0	19.5	17.2	22
24	26.4	26.5	27.2	27.0	26.9	26.4	26.1	24.7	21.7	19.2	17.0	24
26	23.6	23.7	24.3	24.3	24.2	24.2	24.0	23.7	21.5	19.0	16.7	26
28		21.4	22.0	21.9	21.8	21.8	21.6	21.6	21.2	18.7	16.5	28
30		18.5	20.0	19.9	19.8	19.7	19.6	19.5	19.4	18.4	16.2	30
32			18.3	18.2	18.1	18.1	17.9	17.8	17.7	17.6	15.9	32
34				16.7	16.7	16.6	16.5	16.4	16.3	16.1	15.7	34
36					15.4	15.3	15.2	15.1	15.0	14.9	14.8	36
38					14.0	14.2	14.1	14.0	13.9	13.8	13.6	38
40						13.2	13.1	13.0	12.9	12.8	12.7	40
42							12.2	12.1	12.0	11.9	11.8	42
44							10.6	11.4	11.3	11.1	11.0	44
46								10.6	10.5	10.4	10.3	46
48									9.9	9.8	9.7	48
50									8.2	9.2	9.1	50
52										8.2	8.6	52
54											8.0	54
56											6.3	56
Counter weight(t)	68+20											Counter weight(t)
Parts of line	4	4	4	3	3	3	3	2	2	2	2	Parts of line

LJ Load Chart

SCC1800A Crawler Crane -- LJ Load Chart 6/10

Aux. hook, boom 40m, boom angle 84°												
Jib length (m) Radius (m)	22	25	28	31	34	37	40	43	46	49	52	Jib length (m) Radius (m)
14	45.6	44.5										14
16	40.5	40.0	39.1	38.4	35.1							16
18	36.2	35.9	35.5	34.8	34.1	30.9	27.5					18
20	32.6	32.2	32.2	31.6	31.2	30.5	27.3	24.2	21.5	19.1		20
22	29.7	29.3	29.2	28.8	28.4	28.0	27.1	24.0	21.2	18.9	16.7	22
24	26.9	26.8	26.8	26.5	26.1	25.7	25.5	23.8	21.0	18.7	16.5	24
26	24.0	24.1	24.5	24.2	24.0	23.7	23.5	23.1	20.8	18.4	16.3	26
28		21.7	22.3	22.2	22.2	22.0	21.8	21.5	20.5	18.2	16.0	28
30		19.7	20.3	20.2	20.1	20.0	19.9	19.8	19.6	17.9	15.8	30
32			18.5	18.4	18.4	18.3	18.2	18.1	18.0	17.7	15.5	32
34				17.0	16.9	16.8	16.7	16.6	16.5	16.4	15.3	34
36				14.8	15.6	15.5	15.4	15.3	15.2	15.1	14.9	36
38					14.5	14.4	14.3	14.2	14.1	13.9	13.8	38
40						13.4	13.3	13.2	13.1	12.9	12.8	40
42							12.4	12.3	12.2	12.0	11.9	42
44							11.4	11.5	11.4	11.2	11.1	44
46								10.6	10.7	10.5	10.4	46
48									9.8	9.9	9.8	48
50									8.7	9.1	9.1	50
52										8.3	8.4	52
54											7.7	54
56											6.8	56
Counter weight(t) Parts of line	68+20											Counter weight(t) Parts of line
	4	4	3	3	3	3	3	2	2	2	2	

Unit: t

LJ Load Chart

SCC1800A Crawler Crane -- LJ Load Chart 7/10												
Aux. hook, boom 43m, boom angle 84°												
Jib length (m) Radius (m)	22	25	28	31	34	37	40	43	46	49	52	Jib length (m) Radius (m)
14	44.0	43.3										14
16	39.5	38.8	38.0	37.2								16
18	35.3	34.8	34.5	34.0	33.1	29.4	26.3					18
20	31.9	31.5	31.3	30.9	30.3	29.2	26.1	23.2	20.6			20
22	28.9	28.7	28.5	28.1	27.7	27.2	25.9	23.0	20.5	18.2	16.2	22
24	26.4	26.3	26.1	25.8	25.5	25.1	24.8	22.8	20.2	18.0	16.0	24
26	24.3	24.0	23.9	23.8	23.5	23.2	23.0	22.5	20.0	17.8	15.8	26
28		22.0	22.2	21.9	21.7	21.4	21.3	20.9	19.8	17.6	15.6	28
30		20.0	20.5	20.3	20.2	19.8	19.7	19.4	19.2	17.3	15.3	30
32			18.8	18.7	18.6	18.5	18.3	18.1	17.9	17.1	15.1	32
34				17.2	17.1	17.0	16.9	16.8	16.6	16.3	14.9	34
36				15.8	15.8	15.7	15.6	15.5	15.4	15.2	14.6	36
38					14.5	14.6	14.4	14.3	14.2	14.1	13.9	38
40						13.3	13.4	13.3	13.2	13.1	12.9	40
42						12.1	12.3	12.4	12.3	12.2	12.1	42
44							11.1	11.4	11.4	11.4	11.2	44
46								10.3	10.4	10.5	10.4	46
48								9.3	9.5	9.7	9.6	48
50									8.7	8.9	8.9	50
52										8.2	8.2	52
54											7.6	54
56											6.9	56
Counter weight(t)	68+20											Counter weight(t)
Parts of line	4	4	3	3	3	3	2	2	2	2	2	Parts of line

LJ Load Chart

SCC1800A Crawler Crane -- LJ Load Chart 8/10												
Aux. hook, boom 46m, boom angle 84°												
Jib length (m) Radius (m)	22	25	28	31	34	37	40	43	46	49	52	Jib length (m) Radius (m)
14	42.9	41.8										14
16	38.3	37.7	36.9	35.2								16
18	34.3	34.0	33.5	32.9	31.2	27.9						18
20	31.1	30.8	30.4	30.1	29.5	27.7	24.8	22.2	19.8			20
22	28.4	28.0	27.9	27.4	27.0	26.6	24.6	22.0	19.6	17.5	15.7	22
24	25.8	25.8	25.4	25.3	24.9	24.4	24.2	21.8	19.4	17.3	15.5	24
26	23.7	23.5	23.4	23.3	22.9	22.6	22.3	21.5	19.2	17.1	15.3	26
28	22.0	21.8	21.7	21.5	21.2	21.0	20.6	20.4	18.9	16.9	15.1	28
30		20.3	20.1	19.8	19.6	19.4	19.3	19.0	18.5	16.7	14.8	30
32			18.6	18.4	18.3	18.1	17.9	17.8	17.3	16.5	14.6	32
34				17.2	17.0	16.9	16.8	16.6	16.3	15.7	14.4	34
36				15.4	15.6	15.7	15.6	15.4	15.1	14.7	14.1	36
38					14.0	14.2	14.3	14.2	14.0	13.7	13.3	38
40						12.9	13.1	13.0	13.0	12.7	12.5	40
42						11.6	11.8	11.9	11.9	11.8	11.6	42
44							10.8	10.9	10.9	11.0	10.7	44
46								9.9	10.0	10.1	10.0	46
48								9.1	9.1	9.3	9.2	48
50									8.4	8.5	8.5	50
52										7.8	7.8	52
54										7.2	7.2	54
56											6.6	56
Counter weight(t) Parts of line	68+20											Counter weight(t) Parts of line
	4	4	3	3	3	3	2	2	2	2	2	

Unit: t

LJ Load Chart

SCC1800A Crawler Crane -- LJ Load Chart 9/10												
Aux. hook, boom 49m, boom angle 84°												
Jib length (m) Radius (m)	22	25	28	31	34	37	40	43	46	49	52	Jib length (m) Radius (m)
14	41.5											14
16	37.2	36.6	35.8	33.0								16
18	33.5	33.0	32.6	32.1	29.4	26.4						18
20	30.4	30.0	29.6	29.2	28.7	26.1	23.6	21.1	18.9			20
22	27.8	27.4	27.0	26.8	26.5	25.8	23.3	20.9	18.7	16.8	15.0	22
24	25.3	25.2	25.0	24.5	24.4	23.8	23.0	20.7	18.5	16.7	14.9	24
26	23.4	23.1	22.9	22.8	22.4	22.0	21.8	20.4	18.3	16.5	14.7	26
28	21.5	21.4	21.3	21.0	20.8	20.4	20.2	19.8	18.1	16.3	14.5	28
30		19.8	19.7	19.5	19.3	19.0	18.9	18.5	17.8	16.0	14.3	30
32			18.3	18.1	17.9	17.6	17.5	17.2	16.9	15.8	14.1	32
34			16.8	16.9	16.7	16.6	16.4	16.1	15.8	15.1	13.9	34
36				15.4	15.5	15.4	15.3	15.1	14.7	14.2	13.6	36
38					13.9	14.0	14.0	13.9	13.6	13.3	12.9	38
40						12.7	12.8	12.8	12.7	12.5	12.1	40
42						11.6	11.7	11.7	11.7	11.6	11.3	42
44							10.6	10.8	10.7	10.7	10.5	44
46								9.8	9.9	9.9	9.8	46
48								9.0	9.0	9.1	9.1	48
50									8.3	8.4	8.4	50
52										7.7	7.7	52
54										7.1	7.1	54
56											6.5	56
Counter weight(t)	68+20											Counter weight(t)
Parts of line	4	3	3	3	3	2	2	2	2	2	2	Parts of line

LJ Load Chart

SCC1800A Crawler Crane -- LJ Load Chart 10/10												
Aux. hook, boom 52m, boom angle 84°												
Jib length (m) Radius (m)	22	25	28	31	34	37	40	43	46	49	52	Jib length (m) Radius (m)
14	40.2											14
16	36.1	35.5	34.1									16
18	32.5	32.1	31.7	30.4	27.5	24.8						18
20	29.6	29.2	28.9	28.5	27.1	24.5	22.3	20.0				20
22	27.1	26.7	26.4	26.0	25.6	24.2	22.0	19.8	17.8	16.1	14.4	22
24	24.8	24.6	24.4	24.0	23.7	23.2	21.7	19.6	17.6	15.9	14.2	24
26	22.9	22.6	22.4	22.2	21.8	21.6	21.2	19.3	17.4	15.7	14.0	26
28	21.1	20.9	20.8	20.5	20.3	20.0	19.7	19.0	17.2	15.5	13.9	28
30		19.4	19.3	19.0	18.8	18.5	18.3	18.0	16.9	15.3	13.7	30
32			17.9	17.7	17.5	17.2	17.2	16.8	16.1	15.0	13.5	32
34			16.3	16.4	16.4	16.1	15.9	15.6	15.1	14.6	13.2	34
36				14.8	14.9	14.8	14.7	14.5	14.0	13.7	13.0	36
38					13.5	13.4	13.5	13.4	13.1	12.8	12.3	38
40						12.2	12.3	12.3	12.3	12.1	11.9	40
42							11.1	11.3	11.3	11.2	11.1	42
44								10.3	10.4	10.3	10.2	44
46								9.4	9.4	9.5	9.5	46
48									8.6	8.7	8.8	48
50										8.0	8.1	50
52											7.4	52
54											6.8	54
56											6.3	56
Counter weight(t) Parts of line	68+20											Counter weight(t) Parts of line
	3	3	3	3	3	2	2	2	2	2	2	

Unit: t

LJ Load Chart

SCC1800A Crawler Crane -- LJ Load Chart 1/11												
Aux. hook, boom 25m, boom angle 75°												
Jib length (m) Radius (m)	22	25	28	31	34	37	40	43	46	49	52	Jib length (m) Radius (m)
20	38.6	38.4										20
22	34.3	34.2	34.0	33.7								22
24	30.8	30.7	30.5	30.3	30.1							24
26	27.5	27.6	27.6	27.4	27.3	27.1	26.9					26
28	24.5	24.6	25.2	25.0	24.9	24.7	24.5	24.3				28
30		22.1	22.7	22.5	22.4	22.3	22.1	22.0	21.5	18.8		30
32		20.0	20.6	20.4	20.3	20.2	20.0	19.9	19.8	18.6	16.2	32
34			18.8	18.7	18.6	18.4	18.3	18.1	18.0	17.8	16.0	34
36				17.2	17.1	16.9	16.8	16.6	16.5	16.3	15.7	36
38				15.8	15.7	15.6	15.4	15.3	15.2	15.0	14.9	38
40					14.6	14.5	14.3	14.2	14.0	13.9	13.8	40
42						13.5	13.3	13.2	13.0	12.9	12.8	42
44						11.8	12.4	12.3	12.2	12.0	11.9	44
46							11.6	11.5	11.4	11.2	11.1	46
48								10.8	10.6	10.5	10.4	48
50								9.2	10.0	9.8	9.7	50
52									9.2	9.3	9.1	52
54										8.7	8.6	54
56											8.1	56
58											7.1	58
Counter weight(t) Parts of line	68+20											Counter weight(t) Parts of line
	3	3	3	3	3	3	2	2	2	2	2	

LJ Load Chart

SCC1800A Crawler Crane -- LJ Load Chart 2/11												
Aux. hook, boom 28m, boom angle 75°												
Jib length (m) Radius (m)	22	25	28	31	34	37	40	43	46	49	52	Jib length (m) Radius (m)
20	38.1											20
22	33.9	33.8	33.6									22
24	30.5	30.3	30.1	29.9	29.7							24
26	27.6	27.5	27.3	27.1	26.9	26.8						26
28	25.2	25.1	24.9	24.7	24.6	24.4	24.2	24.0				28
30	22.9	23.0	22.9	22.7	22.5	22.4	22.2	22.0	21.2			30
32		20.8	21.1	20.9	20.8	20.6	20.4	20.3	20.1	18.3	16.0	32
34			19.5	19.4	19.3	19.1	18.9	18.8	18.6	18.1	15.8	34
36			17.9	17.8	17.7	17.6	17.5	17.4	17.2	17.0	15.6	36
38				16.4	16.3	16.2	16.1	16.0	15.8	15.7	15.4	38
40					15.1	15.0	14.9	14.8	14.6	14.5	14.3	40
42						14.0	13.9	13.8	13.7	13.6	13.4	42
44							13.0	12.9	12.7	12.6	12.5	44
46								12.0	11.9	11.8	11.6	46
48									11.2	11.0	10.9	48
50									10.5	10.3	10.2	50
52										9.7	9.6	52
54											9.0	54
56											8.5	56
58											7.9	58
Counter weight(t) Parts of line	68+20											Counter weight(t) Parts of line
	3	3	3	3	3	2	2	2	2	2	2	

Unit: t

LJ Load Chart

SCC1800A Crawler Crane -- LJ Load Chart 3/11												
Aux. hook, boom 31m, boom angle 75°												
Jib length (m) Radius (m)	22	25	28	31	34	37	40	43	46	49	52	Jib length (m) Radius (m)
20	37.7											20
22	33.5	33.3										22
24	30.1	29.9	29.7	29.5								24
26	27.3	27.1	27.0	26.7	26.6	26.4						26
28	24.9	24.8	24.6	24.4	24.2	24.0	23.8					28
30	22.9	22.8	22.6	22.4	22.2	22.1	21.8	21.7	20.8			30
32		21.0	20.9	20.7	20.5	20.3	20.1	20.0	19.8	18.0		32
34		19.5	19.3	19.1	19.0	18.8	18.6	18.5	18.3	17.9	15.6	34
36			18.0	17.8	17.7	17.5	17.3	17.2	17.0	16.8	15.4	36
38				16.6	16.5	16.4	16.1	16.0	15.8	15.6	15.2	38
40				15.5	15.4	15.3	15.1	15.0	14.8	14.6	14.4	40
42					14.4	14.3	14.2	14.0	13.9	13.6	13.5	42
44						13.4	13.2	13.1	13.0	12.8	12.7	44
46							12.3	12.2	12.1	12.0	11.9	46
48							11.5	11.5	11.3	11.2	11.1	48
50								10.7	10.6	10.5	10.4	50
52									10.0	9.8	9.7	52
54									9.4	9.3	9.1	54
56										8.7	8.6	56
58											8.1	58
60											7.7	60
Counter weight(t) Parts of line	68+20											Counter weight(t) Parts of line
	3	3	3	3	2	2	2	2	2	2	2	

LJ Load Chart

SCC1800A Crawler Crane -- LJ Load Chart 4/11

SCC1800A Crawler Crane -- LJ Load Chart 4/11												
Aux. hook, boom 34m, boom angle 75°												
Jib length (m) Radius (m)	22	25	28	31	34	37	40	43	46	49	52	Jib length (m) Radius (m)
22	33.1	32.9										22
24	29.7	29.6	29.4									24
26	27.0	26.8	26.6	26.4	26.2							26
28	24.6	24.5	24.3	24.1	23.9	23.7	23.5					28
30	22.6	22.5	22.3	22.1	21.9	21.8	21.5	21.4				30
32	20.8	20.8	20.6	20.4	20.2	20.1	19.8	19.7	19.5	17.7		32
34		19.2	19.1	18.9	18.7	18.6	18.4	18.2	18.0	17.5	15.3	34
36			17.8	17.6	17.4	17.3	17.1	16.9	16.7	16.5	15.1	36
38				16.4	16.3	16.1	15.9	15.8	15.6	15.4	15.0	38
40				15.3	15.2	15.1	14.9	14.7	14.6	14.3	14.2	40
42					14.3	14.2	13.9	13.8	13.6	13.4	13.3	42
44						13.3	13.1	13.0	12.8	12.6	12.4	44
46						12.5	12.3	12.2	12.1	11.8	11.7	46
48							11.6	11.5	11.4	11.2	11.0	48
50								10.9	10.7	10.5	10.4	50
52								10.3	10.1	9.9	9.8	52
54									9.6	9.4	9.3	54
56										8.9	8.8	56
58										8.4	8.3	58
60											7.8	60
Counter weight(t) Parts of line	68+20											Counter weight(t) Parts of line
	3	3	3	2	2	2	2	2	2	2	2	

Unit: t

LJ Load Chart

SCC1800A Crawler Crane -- LJ Load Chart 5/11												
Aux. hook, boom 37m, boom angle 75°												
Jib length (m) Radius (m)	22	25	28	31	34	37	40	43	46	49	52	Jib length (m) Radius (m)
22	32.6											22
24	29.3	29.2	28.9									24
26	26.6	26.4	26.2	26.0								26
28	24.3	24.1	23.9	23.7	23.5	23.3						28
30	22.3	22.2	22.0	21.7	21.6	21.4	21.2					30
32	20.6	20.5	20.3	20.1	19.9	19.7	19.5	19.3	19.2			32
34		19.0	18.8	18.6	18.5	18.3	18.0	17.9	17.7	17.2	15.1	34
36			17.5	17.3	17.2	17.0	16.8	16.6	16.4	16.2	14.9	36
38			16.3	16.1	16.0	15.9	15.6	15.5	15.3	15.1	14.7	38
40				15.1	15.0	14.8	14.6	14.5	14.3	14.1	13.9	40
42					14.1	13.9	13.7	13.6	13.4	13.2	13.0	42
44					13.2	13.1	12.9	12.7	12.6	12.4	12.2	44
46						12.3	12.1	12.0	11.8	11.6	11.5	46
48							11.4	11.3	11.1	10.9	10.8	48
50							10.8	10.7	10.5	10.3	10.2	50
52								10.1	9.9	9.7	9.6	52
54									9.4	9.2	9.1	54
56									8.9	8.7	8.6	56
58										8.3	8.1	58
60											7.7	60
Counter weight(t) Parts of line	68+20											Counter weight(t) Parts of line
	3	3	3	2	2	2	2	2	2	2	2	

LJ Load Chart

SCC1800A Crawler Crane -- LJ Load Chart 6/11												
Aux. hook, boom 40m, boom angle 75°												
Jib length (m) Radius (m)	22	25	28	31	34	37	40	43	46	49	52	Jib length (m) Radius (m)
22	32.1											22
24	28.9	28.7										24
26	26.2	26.0	25.8	25.6								26
28	23.9	23.8	23.6	23.3	23.1							28
30	22.0	21.8	21.6	21.4	21.2	21.1	20.8					30
32	20.3	20.2	20.0	19.7	19.6	19.4	19.2	19.0				32
34		18.7	18.5	18.3	18.1	18.0	17.7	17.6	17.4	16.8		34
36		17.4	17.2	17.0	16.9	16.7	16.5	16.3	16.1	15.9	14.6	36
38			16.1	15.9	15.7	15.6	15.4	15.2	15.0	14.8	14.4	38
40				14.9	14.7	14.6	14.4	14.2	14.0	13.8	13.6	40
42				13.9	13.8	13.7	13.5	13.3	13.1	12.9	12.8	42
44					13.0	12.9	12.6	12.5	12.3	12.1	12.0	44
46						12.1	11.9	11.8	11.6	11.4	11.2	46
48						11.4	11.2	11.1	10.9	10.7	10.6	48
50							10.6	10.5	10.3	10.1	10.0	50
52								9.9	9.7	9.5	9.4	52
54									9.2	9.0	8.9	54
56									8.7	8.5	8.4	56
58										8.1	7.9	58
60											7.5	60
62											7.1	62
Counter weight(t) Parts of line	68+20											Counter weight(t) Parts of line
	3	3	2	2	2	2	2	2	2	2	2	

Unit: t

LJ Load Chart

SCC1800A Crawler Crane -- LJ Load Chart 7/11												
Aux. hook, boom 43m, boom angle 75°												
Jib length (m) Radius (m)	22	25	28	31	34	37	40	43	46	49	52	Jib length (m) Radius (m)
24	28.4	28.2										24
26	25.8	25.6	25.4									26
28	23.5	23.4	23.2	22.9	22.7							28
30	21.6	21.5	21.3	21.0	20.9	20.7						30
32	19.9	19.8	19.6	19.4	19.2	19.1	18.8	18.6				32
34	18.5	18.4	18.2	18.0	17.8	17.6	17.4	17.2	17.0			34
36		17.1	16.9	16.7	16.6	16.4	16.2	16.0	15.8	15.6	14.2	36
38			15.8	15.6	15.5	15.3	15.1	14.9	14.7	14.5	14.1	38
40			14.8	14.6	14.5	14.3	14.1	13.9	13.7	13.5	13.3	40
42				13.7	13.6	13.4	13.2	13.0	12.9	12.6	12.5	42
44					12.8	12.6	12.4	12.2	12.1	11.8	11.7	44
46					12.0	11.9	11.7	11.5	11.4	11.1	11.0	46
48						11.2	11.0	10.9	10.7	10.5	10.3	48
50							10.4	10.2	10.1	9.9	9.7	50
52								9.7	9.5	9.3	9.2	52
54								9.2	9.0	8.8	8.7	54
56									8.5	8.3	8.2	56
58										7.9	7.7	58
60										7.5	7.3	60
62											6.9	62
Counter weight(t) Parts of line	68+20											Counter weight(t) Parts of line
	3	3	2	2	2	2	2	2	2	2	2	

LJ Load Chart

SCC1800A Crawler Crane -- LJ Load Chart 8/11												
Aux. hook, boom 46m, boom angle 75°												
Jib length (m) Radius (m)	22	25	28	31	34	37	40	43	46	49	52	Jib length (m) Radius (m)
24	27.9											24
26	25.4	25.2	24.9									26
28	23.2	23.0	22.8	22.5								28
30	21.3	21.1	20.9	20.7	20.5	20.2						30
32	19.6	19.5	19.3	19.1	18.9	18.7	18.4					32
34	18.2	18.1	17.9	17.7	17.5	17.3	17.1	16.9	16.6			34
36		16.8	16.7	16.4	16.3	16.1	15.9	15.7	15.5	15.2		36
38		15.7	15.6	15.3	15.2	15.0	14.8	14.6	14.4	14.2	13.7	38
40			14.5	14.3	14.2	14.0	13.8	13.6	13.5	13.2	13.1	40
42				13.5	13.3	13.2	12.9	12.8	12.6	12.4	12.2	42
44					12.5	12.4	12.1	12.0	11.8	11.6	11.4	44
46					11.8	11.6	11.4	11.3	11.1	10.9	10.7	46
48						11.0	10.8	10.6	10.5	10.2	10.1	48
50							10.2	10.0	9.9	9.7	9.5	50
52							9.6	9.5	9.3	9.1	9.0	52
54								9.0	8.8	8.6	8.5	54
56									8.3	8.1	8.0	56
58									7.9	7.7	7.6	58
60										7.3	7.2	60
62											6.8	62
64											6.4	64
Counter weight(t) Parts of line	68+20											Counter weight(t) Parts of line
	3	2	2	2	2	2	2	2	2	2	2	

Unit: t

LJ Load Chart

SCC1800A Crawler Crane -- LJ Load Chart 10/11												
Aux. hook, boom 49m, boom angle 75°												
Jib length (m) Radius (m)	22	25	28	31	34	37	40	43	46	49	52	Jib length (m) Radius (m)
26	24.9	24.6										26
28	22.7	22.6	22.3									28
30	20.9	20.7	20.5	20.3	20.0							30
32	19.3	19.2	19.0	18.7	18.5	18.3	17.9					32
34	17.9	17.8	17.6	17.3	17.2	17.0	16.7	16.4				34
36	16.6	16.5	16.3	16.1	15.9	15.8	15.5	15.3	15.1	14.7		36
38		15.4	15.3	15.0	14.9	14.7	14.5	14.3	14.1	13.8	13.3	38
40			14.3	14.1	13.9	13.7	13.5	13.3	13.2	12.9	12.7	40
42				13.2	13.1	12.9	12.7	12.5	12.3	12.1	11.9	42
44				12.4	12.3	12.1	11.9	11.7	11.5	11.3	11.1	44
46					11.5	11.4	11.2	11.0	10.9	10.6	10.5	46
48						10.7	10.5	10.4	10.2	10.0	9.8	48
50						10.1	9.9	9.8	9.6	9.4	9.3	50
52							9.4	9.3	9.1	8.9	8.7	52
54								8.8	8.6	8.4	8.2	54
56								8.3	8.1	7.9	7.8	56
58									7.7	7.5	7.4	58
60										7.1	7.0	60
62										6.7	6.6	62
64											6.2	64
Counter weight(t) Parts of line	68+20											Counter weight(t) Parts of line
	2	2	2	2	2	2	2	2	2	2	1	

LJ Load Chart**SCC1800A Crawler Crane -- LJ Load Chart 11/11**

SCC1800A Crawler Crane -- LJ Load Chart 11/11												
Aux. hook, boom 52m, boom angle 75°												
Jib length (m) Radius (m)	22	25	28	31	34	37	40	43	46	49	52	Jib length (m) Radius (m)
26	24.2											26
28	22.3	22.1	21.7									28
30	20.5	20.3	20.1	19.7								30
32	18.9	18.8	18.6	18.3	18.0	17.7						32
34	17.5	17.4	17.2	17.0	16.8	16.6	16.2	15.9				34
36	16.3	16.2	16.0	15.8	15.6	15.4	15.1	14.9	14.5			36
38		15.1	15.0	14.7	14.6	14.4	14.1	13.9	13.6	13.3	12.8	38
40			14.0	13.8	13.6	13.4	13.2	13.0	12.8	12.5	12.2	40
42			13.1	12.9	12.8	12.6	12.4	12.2	12.0	11.7	11.5	42
44				12.1	12.0	11.8	11.6	11.4	11.3	11.0	10.8	44
46					11.3	11.1	10.9	10.8	10.6	10.3	10.2	46
48					10.6	10.5	10.3	10.1	10.0	9.7	9.6	48
50						9.9	9.7	9.6	9.4	9.2	9.0	50
52							9.2	9.0	8.9	8.6	8.5	52
54							8.7	8.5	8.4	8.2	8.0	54
56								8.1	7.9	7.7	7.6	56
58									7.5	7.3	7.1	58
60										6.9	6.7	60
62										6.5	6.4	62
64											6.0	64
Counter weight(t) Parts of line	68+20											Counter weight(t) Parts of line
	2	2	2	2	2	2	2	2	2	1	1	

Unit: t

LJ Load Chart

SCC1800A Crawler Crane -- LJ Load Chart 1/10												
Aux. hook, boom 25m, boom angle 65°												
Jib length (m) Radius (m)	22	25	28	31	34	37	40	43	46	49	52	Jib length (m) Radius (m)
26	26.6											26
28	24.3	24.1										28
30	22.3	22.1	22.0									30
32	20.6	20.5	20.3	20.0								32
34		19.0	18.8	18.6	18.4							34
36		17.6	17.5	17.3	17.1	17.0	16.7					36
38			16.3	16.1	16.0	15.8	15.6	15.4				38
40				15.1	15.0	14.8	14.6	14.4	14.2			40
42				14.1	14.0	13.9	13.7	13.5	13.3	13.1		42
44					13.2	13.0	12.8	12.7	12.5	12.3	12.1	44
46						12.3	12.1	11.9	11.8	11.6	11.4	46
48						11.6	11.4	11.3	11.1	10.9	10.7	48
50							10.8	10.6	10.5	10.3	10.1	50
52								10.1	9.9	9.7	9.5	52
54								9.5	9.4	9.2	9.0	54
56									8.9	8.7	8.5	56
58										8.2	8.1	58
60										7.8	7.7	60
62											7.3	62
Counter weight(t)	68+20											Counter weight(t)
Parts of line	2	2	2	2	2	2	2	2	2	1	1	Parts of line

LJ Load Chart

SCC1800A Crawler Crane -- LJ Load Chart 2/10												
Aux. hook, boom 28m, boom angle 65°												
Jib length (m) Radius (m)	22	25	28	31	34	37	40	43	46	49	52	Jib length (m) Radius (m)
28	23.8											28
30	21.8	21.7										30
32	20.1	20.0	19.8	19.6								32
34	18.7	18.6	18.4	18.1	18.0							34
36		17.3	17.1	16.9	16.7	16.5						36
38		16.1	16.0	15.7	15.6	15.4	15.2					38
40			14.9	14.7	14.6	14.4	14.2	14.0				40
42				13.8	13.7	13.5	13.3	13.2	13.0			42
44					12.9	12.7	12.5	12.4	12.2	11.9	11.8	44
46					12.1	12.0	11.8	11.6	11.5	11.2	11.1	46
48						11.3	11.1	11.0	10.8	10.6	10.4	48
50							10.5	10.3	10.2	10.0	9.8	50
52							9.9	9.8	9.6	9.4	9.2	52
54								9.2	9.1	8.9	8.7	54
56									8.6	8.4	8.3	56
58									8.2	8.0	7.8	58
60										7.5	7.4	60
62											7.0	62
64											6.6	64
Counter weight(t) Parts of line	68+20											Counter weight(t) Parts of line
	2	2	2	2	2	2	2	2	1	1	1	

Unit: t

LJ Load Chart

SCC1800A Crawler Crane -- LJ Load Chart 3/10												
Aux. hook, boom 31m, boom angle 65°												
Jib length (m) Radius (m)	22	25	28	31	34	37	40	43	46	49	52	Jib length (m) Radius (m)
30	21.3	21.2										30
32	19.7	19.5	19.3									32
34	18.2	18.1	17.9	17.7								34
36	17.0	16.9	16.7	16.4	16.3							36
38		15.7	15.6	15.3	15.2	15.0						38
40			14.6	14.4	14.2	14.0	13.8					40
42			13.7	13.5	13.3	13.2	12.9	12.8	12.6			42
44				12.7	12.5	12.4	12.1	12.0	11.8	11.6		44
46					11.8	11.6	11.4	11.3	11.1	10.9	10.7	46
48					11.1	11.0	10.8	10.6	10.4	10.2	10.1	48
50						10.4	10.2	10.0	9.9	9.6	9.5	50
52							9.6	9.5	9.3	9.1	8.9	52
54								9.0	8.8	8.6	8.4	54
56								8.5	8.3	8.1	8.0	56
58									7.9	7.7	7.5	58
60										7.3	7.1	60
62										6.9	6.8	62
64											6.4	64
Counter weight(t)	68+20											Counter weight(t)
Parts of line	2	2	2	2	2	2	2	1	1	1	1	Parts of line

LJ Load Chart

SCC1800A Crawler Crane -- LJ Load Chart 4/10

SCC1800A Crawler Crane -- LJ Load Chart 4/10												
Aux. hook, boom 34m, boom angle 65°												
Jib length (m) Radius (m)	22	25	28	31	34	37	40	43	46	49	52	Jib length (m) Radius (m)
30	20.9											30
32	19.3	19.1										32
34	17.9	17.7	17.5									34
36	16.6	16.5	16.3	16.0								36
38		15.4	15.2	15.0	14.8	14.6						38
40		14.4	14.2	14.0	13.9	13.7	13.4					40
42			13.4	13.1	13.0	12.8	12.6	12.4				42
44				12.3	12.2	12.0	11.8	11.6	11.5			44
46				11.6	11.5	11.3	11.1	10.9	10.8	10.5		46
48					10.8	10.7	10.5	10.3	10.1	9.9	9.7	48
50						10.1	9.9	9.7	9.6	9.3	9.2	50
52						9.5	9.3	9.2	9.0	8.8	8.6	52
54							8.8	8.7	8.5	8.3	8.1	54
56								8.2	8.1	7.8	7.7	56
58								7.8	7.6	7.4	7.3	58
60									7.2	7.0	6.9	60
62										6.7	6.5	62
64											6.2	64
66											5.8	66
Counter weight(t) Parts of line	68+20											Counter weight(t) Parts of line
	2	2	2	2	2	2	1	1	1	1	1	

Unit: t

LJ Load Chart

SCC1800A Crawler Crane -- LJ Load Chart 5/10												
Aux. hook, boom 37m, boom angle 65°												
Jib length (m) Radius (m)	22	25	28	31	34	37	40	43	46	49	52	Jib length (m) Radius (m)
32	18.8											32
34	17.4	17.2										34
36	16.2	16.0	15.8	15.6								36
38	15.1	15.0	14.8	14.5	14.4							38
40		14.0	13.8	13.6	13.4	13.2						40
42			13.0	12.7	12.6	12.4	12.2					42
44			12.2	12.0	11.8	11.7	11.4	11.2				44
46				11.3	11.1	11.0	10.7	10.6	10.4			46
48					10.5	10.3	10.1	9.9	9.8	9.5	9.4	48
50					9.9	9.8	9.5	9.4	9.2	9.0	8.8	50
52						9.2	9.0	8.9	8.7	8.4	8.3	52
54							8.5	8.4	8.2	8.0	7.8	54
56							8.1	7.9	7.8	7.5	7.4	56
58								7.5	7.3	7.1	7.0	58
60									7.0	6.7	6.6	60
62									6.6	6.4	6.2	62
64										6.0	5.9	64
66											5.6	66
68											5.3	68
Counter weight(t)	68+20											Counter weight(t)
Parts of line	2	2	2	2	2	2	2	1	1	1	1	Parts of line

LJ Load Chart

SCC1800A Crawler Crane -- LJ Load Chart 6/10												
Aux. hook, boom 40m, boom angle 65°												
Jib length (m) Radius (m)	22	25	28	31	34	37	40	43	46	49	52	Jib length (m) Radius (m)
32	18.2											32
34	16.9	16.7										34
36	15.7	15.6	15.4									36
38	14.7	14.5	14.3	14.1								38
40	13.7	13.6	13.4	13.2	13.0							40
42		12.8	12.6	12.3	12.2	12.0						42
44			11.8	11.6	11.4	11.3	11.0	10.8				44
46			11.1	10.9	10.8	10.6	10.3	10.2	10.0			46
48				10.3	10.2	10.0	9.7	9.6	9.4	9.1		48
50					9.6	9.4	9.2	9.0	8.8	8.6	8.4	50
52						8.9	8.7	8.5	8.3	8.1	7.9	52
54						8.4	8.2	8.1	7.9	7.6	7.5	54
56							7.8	7.6	7.4	7.2	7.0	56
58								7.2	7.0	6.8	6.7	58
60								6.8	6.7	6.4	6.3	60
62									6.3	6.1	5.9	62
64										5.8	5.6	64
66										5.4	5.3	66
68											5.0	68
Counter weight(t) Parts of line	68+20											Counter weight(t) Parts of line
	2	2	2	2	1	1	1	1	1	1	1	

Unit: t

LJ Load Chart

SCC1800A Crawler Crane -- LJ Load Chart 7/10												
Aux. hook, boom 43m, boom angle 65°												
Jib length (m) Radius (m)	22	25	28	31	34	37	40	43	46	49	52	Jib length (m) Radius (m)
34	16.4											34
36	15.2	15.1										36
38	14.2	14.1	13.9									38
40	13.3	13.2	13.0	12.7	12.5							40
42		12.4	12.2	11.9	11.7	11.6						42
44		11.6	11.4	11.2	11.0	10.8	10.6					44
46			10.8	10.5	10.4	10.2	9.9	9.8				46
48				9.9	9.8	9.6	9.4	9.2	9.0			48
50				9.4	9.2	9.1	8.8	8.7	8.5	8.2		50
52					8.7	8.6	8.3	8.2	8.0	7.7	7.6	52
54						8.1	7.9	7.7	7.5	7.3	7.1	54
56						7.6	7.4	7.3	7.1	6.9	6.7	56
58							7.0	6.9	6.7	6.5	6.3	58
60								6.5	6.4	6.1	6.0	60
62									6.0	5.8	5.6	62
64									5.7	5.5	5.3	64
66										5.2	5.0	66
68											4.7	68
70											4.5	70
Counter weight(t)	68+20											Counter weight(t)
Parts of line	2	2	2	1	1	1	1	1	1	1	1	Parts of line

LJ Load Chart

SCC1800A Crawler Crane -- LJ Load Chart 8/10												
Aux. hook, boom 46m, boom angle 65°												
Jib length (m) Radius (m)	22	25	28	31	34	37	40	43	46	49	52	Jib length (m) Radius (m)
36	14.8											36
38	13.8	13.6	13.4									38
40	12.9	12.8	12.6	12.3								40
42	12.1	12.0	11.8	11.5	11.3							42
44		11.3	11.1	10.8	10.6	10.4						44
46			10.4	10.2	10.0	9.8	9.6					46
48			9.8	9.6	9.4	9.2	9.0	8.8				48
50				9.0	8.9	8.7	8.5	8.3	8.1	7.8		50
52					8.4	8.2	8.0	7.8	7.6	7.4	7.2	52
54					7.9	7.8	7.5	7.4	7.2	6.9	6.8	54
56						7.4	7.1	7.0	6.8	6.5	6.4	56
58							6.7	6.6	6.4	6.2	6.0	58
60							6.4	6.2	6.1	5.8	5.7	60
62								5.9	5.7	5.5	5.3	62
64									5.4	5.2	5.0	64
66									5.1	4.9	4.7	66
68										4.6	4.5	68
70											4.2	70
Counter weight(t) Parts of line	68+20											Counter weight(t) Parts of line
	2	2	1	1	1	1	1	1	1	1	1	

Unit: t

LJ Load Chart

SCC1800A Crawler Crane -- LJ Load Chart 9/10													
Aux. hook, boom 49m, boom angle 65°													
Jib length (m) Radius (m)	22	25	28	31	34	37	40	43	46	49	52	Jib length (m) Radius (m)	
36	14.3											36	
38	13.3	13.1										38	
40	12.5	12.3	12.1									40	
42	11.7	11.5	11.3	11.0								42	
44	10.9	10.8	10.6	10.4	10.2							44	
46		10.2	10.0	9.8	9.6	9.4	9.1					46	
48			9.4	9.2	9.0	8.8	8.6	8.4				48	
50				8.7	8.5	8.3	8.1	7.9	7.7			50	
52				8.2	8.0	7.9	7.6	7.4	7.2	7.0		52	
54					7.6	7.4	7.2	7.0	6.8	6.6	6.4	54	
56						7.0	6.8	6.6	6.4	6.2	6.0	56	
58							6.6	6.4	6.2	6.1	5.8	5.6	58
60								6.1	5.9	5.7	5.5	5.3	60
62									5.6	5.4	5.2	5.0	62
64									5.3	5.1	4.9	4.7	64
66										4.8	4.6	4.4	66
68											4.3	4.2	68
70											4.1	3.9	70
72												3.7	72
Counter weight(t)	68+20											Counter weight(t)	
Parts of line	2	1	1	1	1	1	1	1	1	1	1	Parts of line	

LJ Load Chart

SCC1800A Crawler Crane -- LJ Load Chart 10/10												
Aux. hook, boom 52m, boom angle 65°												
Jib length (m) Radius (m)	22	25	28	31	34	37	40	43	46	49	52	Jib length (m) Radius (m)
38	12.8											38
40	12.0	11.8										40
42	11.2	11.1	10.9									42
44	10.5	10.4	10.2	9.9	9.7							44
46		9.8	9.6	9.3	9.2	9.0						46
48		9.2	9.0	8.8	8.6	8.4	8.1					48
50			8.5	8.3	8.1	7.9	7.7	7.5				50
52				7.8	7.7	7.5	7.2	7.0	6.8			52
54				7.4	7.2	7.1	6.8	6.6	6.4	6.2		54
56					6.8	6.7	6.4	6.3	6.1	5.8	5.6	56
58						6.3	6.1	5.9	5.7	5.5	5.3	58
60							5.7	5.6	5.4	5.1	5.0	60
62							5.4	5.3	5.1	4.8	4.7	62
64								5.0	4.8	4.6	4.4	64
66									4.5	4.3	4.1	66
68									4.3	4.0	3.9	68
70										3.8	3.6	70
72											3.4	72
74											3.2	74
Counter weight(t) Parts of line	68+20											Counter weight(t) Parts of line
	1	1	1	1	1	1	1	1	1	1	1	



Zhejiang SANY Equipment Co., Ltd.

SANY Industrial Park, No. 2087 Daishan Road, Wuxing District, Huzhou City,
Zhejiang Province, P. R. of China Zip 313028

After-sales Service 400 887 8318

Consulting 400 887 9318

— Agent information —

Due to updated technology, the technical parameters and configurations are subject to change without prior notice. The machine in the picture may include additional equipment. This album is for reference only, subject to the object.

All rights reserved for Sany, without the written permission of Sany, the contents of any part of this content shall not be copied or copied for any purpose.

© Printed in March 2020 in China

www.sany.com.cn



Please scan the official
WeChat account of Sany
for more information.